

15. Millennium Open
Competition Area 4
Senior A M-58

2 competitors
2024-01-20

001 - Bojan Trupković
[SRB] KOLOSEUM

329
(1:2)

456

Nemanja Jovanović - 329
[SRB] KOLOSEUM

1. Nemanja Jovanović ([SRB] KOLOSEUM)
2. Bojan Trupković ([SRB] KOLOSEUM)
3.
3.

15. Millennium Open
Competition Area 5
Senior A M-68

2 competitors
2024-01-20

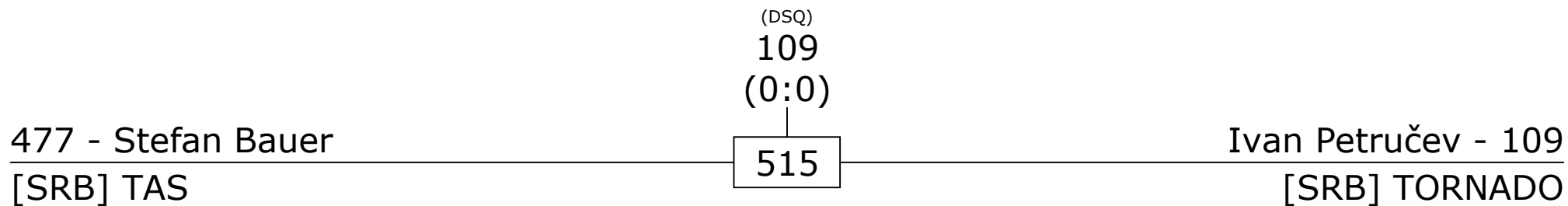

1. Ivan Petručev ([SRB] TORNADO)
2. Stefan Bauer ([SRB] TAS)
3.
3.

15. Millennium Open Competition Area 5 Senior A M-74

3 competitors
2024-01-20

165 - Veljko Panić
[SRB] LETNJKOVAC

Jure Tozon - 455
[SLO] PANTAR

345 - Berghean Darius
[ROU] ASOCIATIA ROMANA DE TAEKWONDO

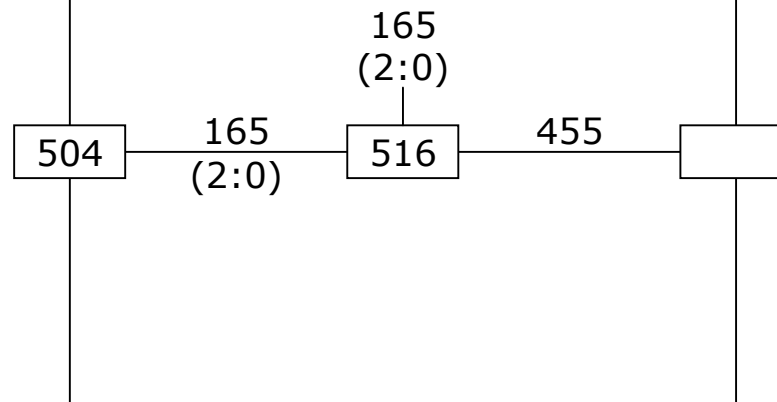

- | |
|--|
| 1. Veljko Panić ([SRB] LETNJKOVAC) |
| 2. Jure Tozon ([SLO] PANTAR) |
| 3. Berghean Darius ([ROU] ASOCIATIA ROMANA DE ...) |
| 3. |

15. Millennium Open Competition Area 5 Senior A M-87

3 competitors
2024-01-20

071 - Razvan Mihai Vladut
[ROU] BLACK TIGER

Bucur Mihai - 469
[ROU] ASOCIATIA ROMANA DE TAEKWONDO

236 - Miloš Jeličić
[BIH] LJUBIJA-PRIJEDOR

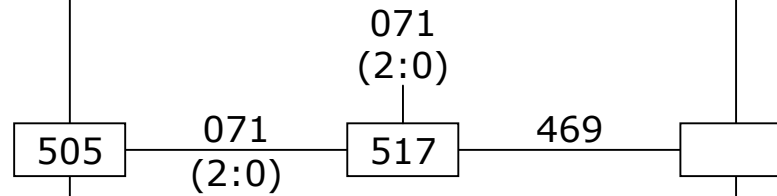

1. Razvan Mihai Vladut ([ROU] BLACK TIGER)
2. Bucur Mihai ([ROU] ASOCIATIA ROMANA DE TAEK...
3. Miloš Jeličić ([BIH] LJUBIJA-PRIJEDOR)
3.

15. Millennium Open Competition Area 5 Senior A M+87

3 competitors
2024-01-20

392 - Radovan Mijanović
[SRB] ZRENJANIN

Karlo Vuletić - 438
[SRB] VIDIKOVAC

476 - Oltean Denis
[ROU] ASOCIATIA ROMANA DE TAEKWONDO

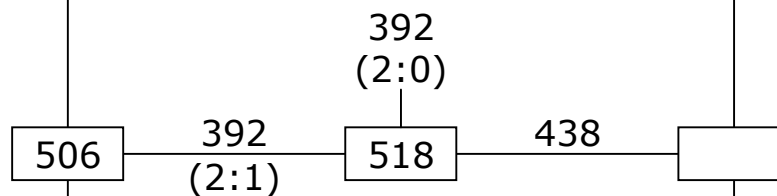

1. Radovan Mijanović ([SRB] ZRENJANIN)
2. Karlo Vuletić ([SRB] VIDIKOVAC)
3. Oltean Denis ([ROU] ASOCIATIA ROMANA DE TAE...
3.

15. Millennium Open
Competition Area 5
Pioniri B (8-9) F-21

2 competitors
2024-01-20

319 - Una Đorđević
[SRB] EUROŠPED

025
(0:2)

535

Nadja Nikolin - 025
[SRB] EUROŠPED

1. Nadja Nikolin ([SRB] EUROŠPED)
2. Una Đorđević ([SRB] EUROŠPED)
3.
3.

15. Millennium Open Competition Area 5 Pioniri B (8-9) F-25

4 competitors
2024-01-20

005 - Mia Rangelov
[SRB] VRŠAC

Mila Krajnovic - 174
[SRB] LETNJKOVAC

009 - Hana PejkoVIC Jovanovic
[SRB] KWON BATAJNICA

Mia Čeki - 335
[SRB] KOLOSEUM

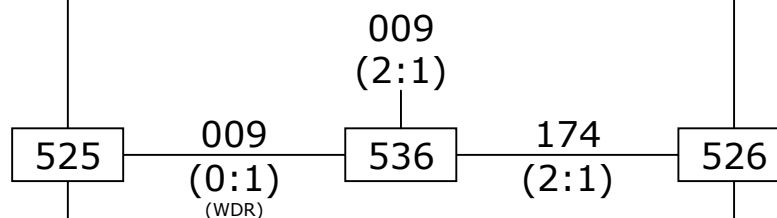

1. Hana PejkoVIC Jovanovic ([SRB] KWON BATAJNICA)
2. Mila Krajnovic ([SRB] LETNJKOVAC)
3. Mia Čeki ([SRB] KOLOSEUM)
3. Mia Rangelov ([SRB] VRŠAC)

15. Millennium Open Competition Area 5 Pioniri B (8-9) F-27

3 competitors
2024-01-20

260 - Nadja Ilijev
[SRB] EUROŠPED

Jana Milosavljević - 338
[SRB] KOLOSEUM

197 - Anja Kostričenko
[SRB] SPARTA

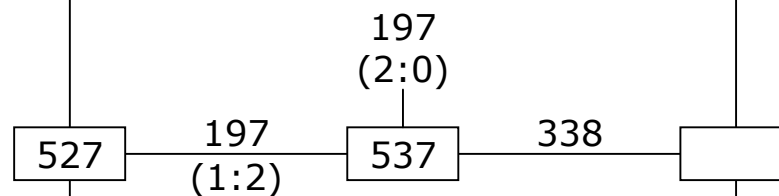

1. Anja Kostričenko ([SRB] SPARTA)

2. Jana Milosavljević ([SRB] KOLOSEUM)

3. Nadja Ilijev ([SRB] EUROŠPED)

3.

15. Millennium Open Competition Area 7 Pioniri B (8-9) F-29

4 competitors
2024-01-20

140 - Helena Đorđević
[SRB] KOLOSEUM

Lena Petrovic - 273
[SRB] STIL

531 - Kalina Mitov
[SRB] EUROŠPED

Helena Vujasic - 010
[SRB] KWON BATAJNICA

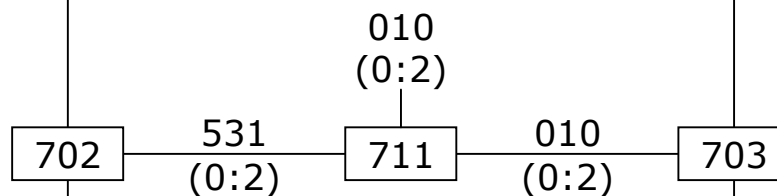

1. Helena Vujasic ([SRB] KWON BATAJNICA)

2. Kalina Mitov ([SRB] EUROŠPED)

3. Lena Petrovic ([SRB] STIL)

3. Helena Đorđević ([SRB] KOLOSEUM)

15. Millennium Open Competition Area 5 Pioniri B (8-9) F-31

3 competitors
2024-01-20

337 - Magdalena Brkić
[SRB] KOLOSEUM

Ena Jaredić - 063
[SRB] CRVENA ZVEZDA

207 - Jovana Milojković
[SRB] ASTERIKS

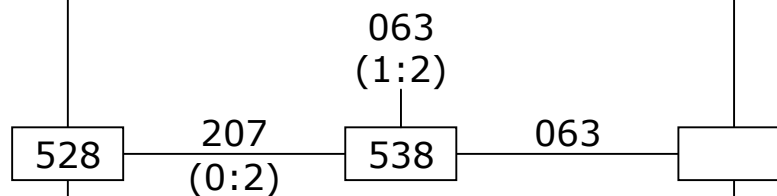

1. Ena Jaredić ([SRB] CRVENA ZVEZDA)

2. Jovana Milojković ([SRB] ASTERIKS)

3. Magdalena Brkić ([SRB] KOLOSEUM)

3.

15. Millennium Open Competition Area 5 Pioniri B (8-9) F-33

4 competitors
2024-01-20

406 - Dunja Andrijin
[SRB] ZRENJANIN

Marta Đuričić - 232
[SRB] AZIJA

328 - Petra Jovančević
[SRB] VOJVODINA

Marijana Ivanovic - 172
[SRB] LETNJKOVAC

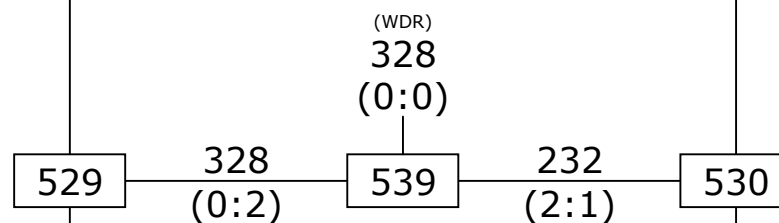

1. Petra Jovančević ([SRB] VOJVODINA)

2. Marta Đuričić ([SRB] AZIJA)

3. Marijana Ivanovic ([SRB] LETNJKOVAC)

3. Dunja Andrijin ([SRB] ZRENJANIN)

15. Millennium Open
Competition Area 7
Pioniri B (8-9) F-36

4 competitors
2024-01-20

156 - Danica Rankov
[SRB] EUROŠPED

Jana Nikolić - 139
[SRB] KOLOSEUM

511 - Monika Spasić
[SRB] TEKVONDO AKADEMIJA

Ana Metlić - 407
[SRB] POBEDNIK

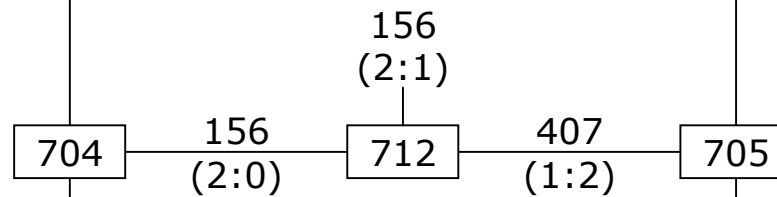

- | |
|---|
| 1. Danica Rankov ([SRB] EUROŠPED) |
| 2. Ana Metlić ([SRB] POBEDNIK) |
| 3. Jana Nikolić ([SRB] KOLOSEUM) |
| 3. Monika Spasić ([SRB] TEKVONDO AKADEMIJA) |

15. Millennium Open Competition Area 5 Pioniri B (8-9) M-21

3 competitors
2024-01-20

483 - Danilo Đordjević
[SRB] VRŠAC

Mihajlo Oreščanin - 095
[SRB] ELIT

021 - Vojin Vrhovac
[SRB] ZMAJ VRDNIK

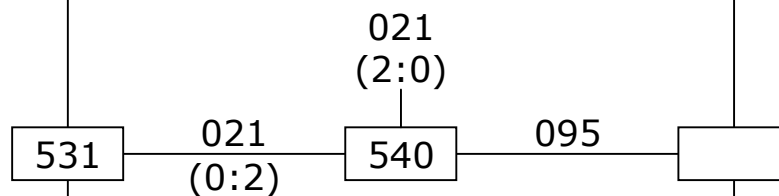

1. Vojin Vrhovac ([SRB] ZMAJ VRDNIK)

2. Mihajlo Oreščanin ([SRB] ELIT)

3. Danilo Đordjević ([SRB] VRŠAC)

3.

15. Millennium Open
Competition Area 5
Pioniri B (8-9) M-25

2 competitors
2024-01-20

028 - Petar Avramovic
[SRB] EUROŠPED

261
(0:2)

541

Aleksa Ilijev - 261
[SRB] EUROŠPED

1. Aleksa Ilijev ([SRB] EUROŠPED)

2. Petar Avramovic ([SRB] EUROŠPED)

3.

3.

15. Millennium Open Competition Area 5 Pioniri B (8-9) M-27

3 competitors
2024-01-20

473 - Todea Patrik

[ROU] ASOCIATIA ROMANA DE TAEKWONDO

Stevan Stanić - 187

[SRB] SPARTA

070 - Stefan Stevanović

[SRB] VINER-ČIVI

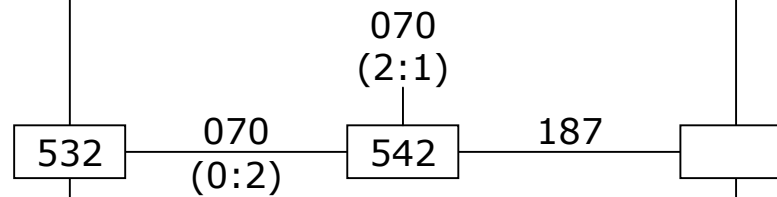

1. Stefan Stevanović ([SRB] VINER-ČIVI)

2. Stevan Stanić ([SRB] SPARTA)

3. Todea Patrik ([ROU] ASOCIATIA ROMANA DE TAE...

3.

15. Millennium Open Competition Area 5 Pioniri B (8-9) M-29

5 competitors
2024-01-20

501 - Nicolas Galea
[ROU] BLACK TIGER

076 - Luka Avramović
[SRB] ŠABAC

112 - Mihajlo Basalić
[SRB] TORNADO

Stir Casian - 474
[ROU] ASOCIATIA ROMANA DE TAEKWONDO

Kosta Ilić - 053
[SRB] ŠABAC

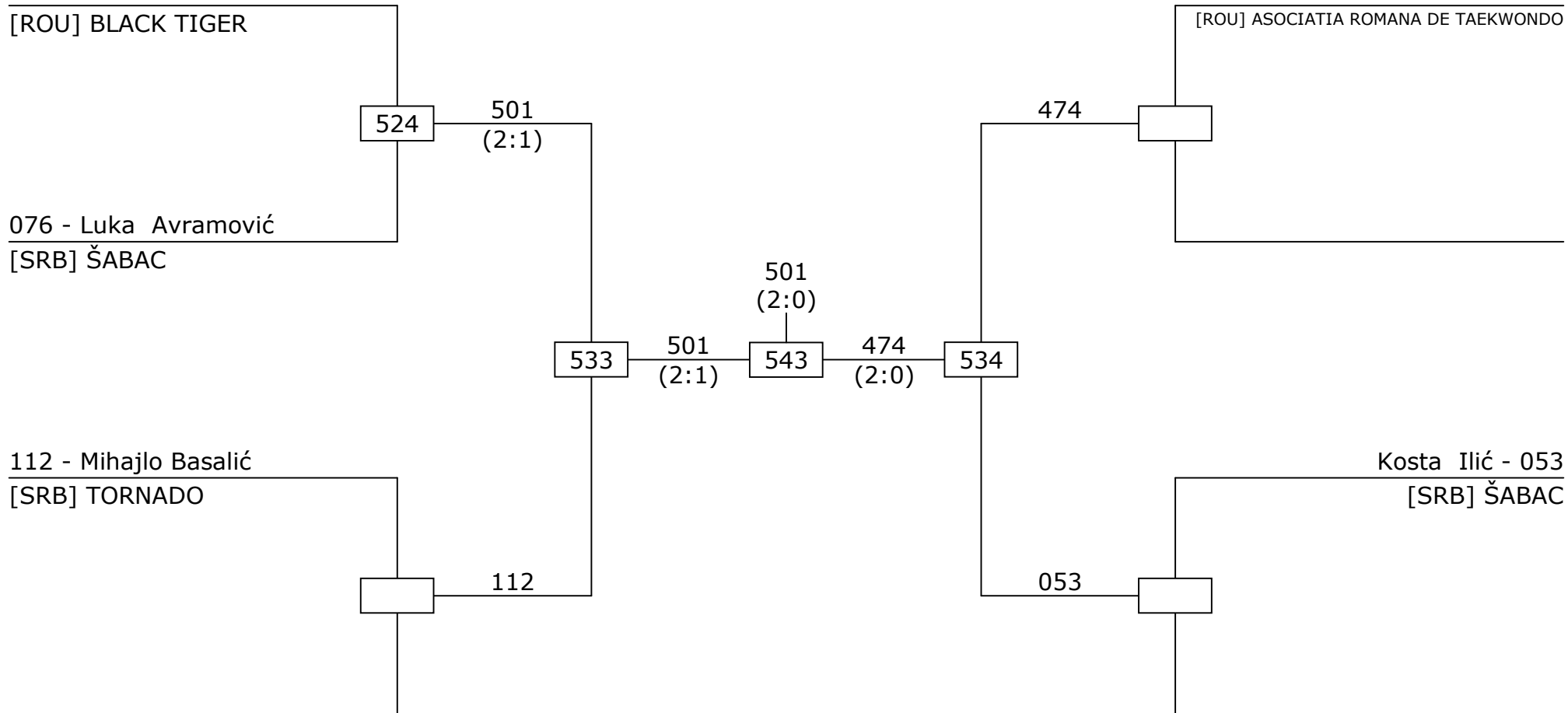

1. Nicolas Galea ([ROU] BLACK TIGER)
2. Stir Casian ([ROU] ASOCIATIA ROMANA DE TAEK...
3. Kosta Ilić ([SRB] ŠABAC)
3. Mihajlo Basalić ([SRB] TORNADO)

15. Millennium Open Competition Area 7 Pioniri B (8-9) M-31

4 competitors
2024-01-20

143 - Silaghi Jozsef

[ROU] ASOCIATIA ROMANA DE TAEKWONDO

Nemeth Peter - 446

[HUN] TAEKWONDO FANATIX

128 - Nikola Savić

[SRB] STIL

Jakov Kuzmanov - 221

[SRB] AZIJA

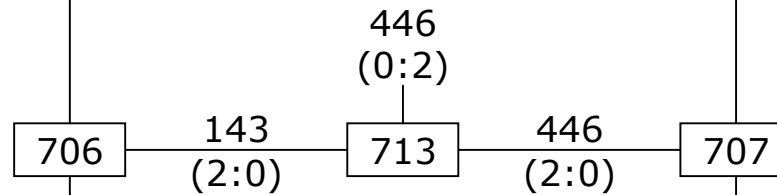

1. Nemeth Peter ([HUN] TAEKWONDO FANATIX)

2. Silaghi Jozsef ([ROU] ASOCIATIA ROMANA DE TA...

3. Jakov Kuzmanov ([SRB] AZIJA)

3. Nikola Savić ([SRB] STIL)

15. Millennium Open Competition Area 7 Pioniri B (8-9) M-33

3 competitors
2024-01-20

408 - Aleksandar Doljančević
[SRB] POBEDNIK

Miljan Plavšić - 213
[SRB] KWON BATAJNICA

361 - Dusan Markovic
[SRB] EUROŠPED

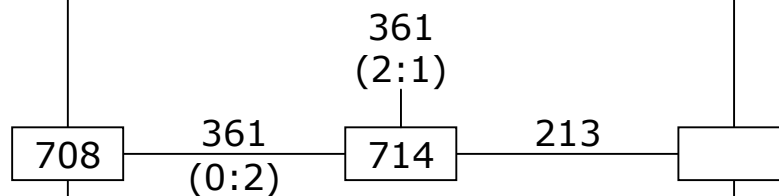

- | |
|--|
| 1. Dusan Markovic ([SRB] EUROŠPED) |
| 2. Miljan Plavšić ([SRB] KWON BATAJNICA) |
| 3. Aleksandar Doljančević ([SRB] POBEDNIK) |
| 3. |

15. Millennium Open Competition Area 7 Pioniri B (8-9) M-36

5 competitors
2024-01-20

171 - Aljoša Gavrilović
[SRB] LETNJIKOVAC

111 - Uroš Radojević
[SRB] TORNADO

237 - Ognjen Kostić
[SRB] ZMAJ

Danilo Kikos - 363
[SRB] EUROŠPED

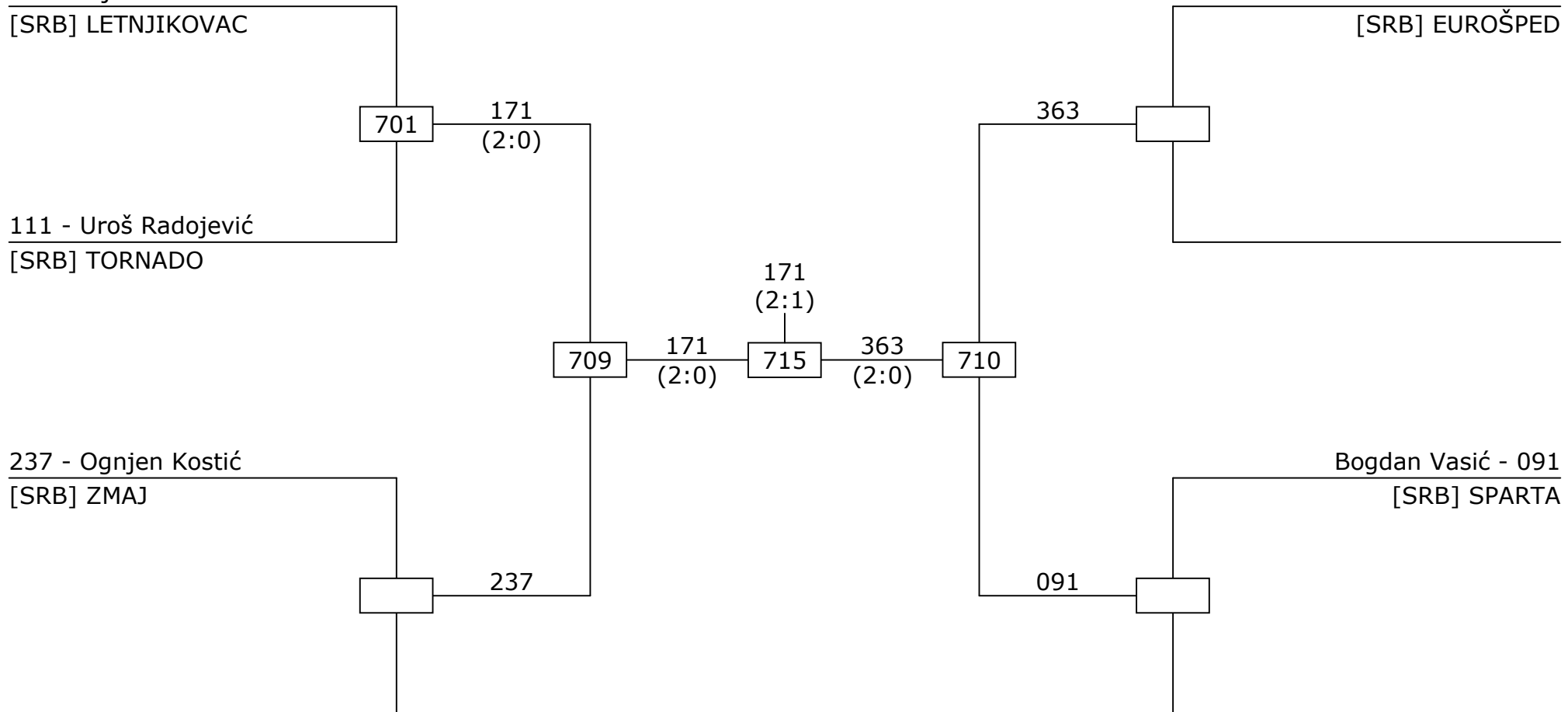

1. Aljoša Gavrilović ([SRB] LETNJIKOVAC)

2. Danilo Kikos ([SRB] EUROŠPED)

3. Bogdan Vasić ([SRB] SPARTA)

3. Ognjen Kostić ([SRB] ZMAJ)

15. Millennium Open
Competition Area 7
Pioniri B (8-9) M-39

2 competitors
2024-01-20

108 - Littasi Andrei	120 (1:2)	Danilo Lazić - 120
[ROU] ASOCIATIA ROMANA DE TAEKWONDO	735	[SRB] OBRENOVAC

1. Danilo Lazić ([SRB] OBRENOVAC)
2. Littasi Andrei ([ROU] ASOCIATIA ROMANA DE TA...
3.
3.

15. Millennium Open
Competition Area 5
Pioniri B (6-7) F-19

2 competitors
2024-01-20

282 - Teodora Aleksić
[SRB] EUROŠPED

349
(0:2)

544

Andjela Nikolin - 349
[SRB] EUROŠPED

1. Andjela Nikolin ([SRB] EUROŠPED)
2. Teodora Aleksić ([SRB] EUROŠPED)
3.
3.

15. Millennium Open
Competition Area 5
Pioniri B (6-7) F-21

2 competitors
2024-01-20

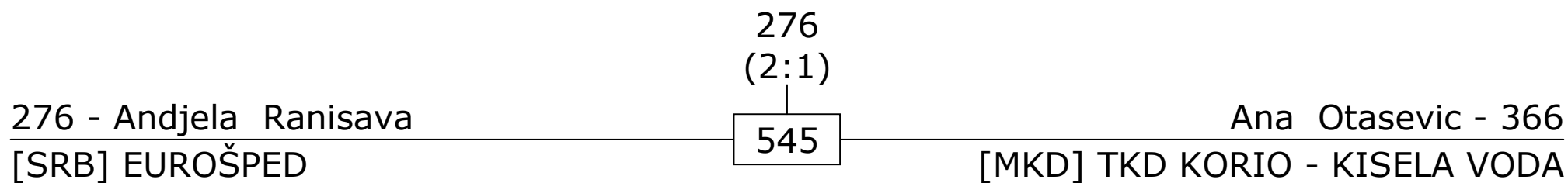

1. Andjela Ranisava ([SRB] EUROŠPED)
2. Ana Otasevic ([MKD] TKD KORIO - KISELA VODA)
3.
3.

15. Millennium Open Competition Area 6 Pioniri B (6-7) F-23

3 competitors
2024-01-20

463 - Littasi Maria

[ROU] ASOCIATIA ROMANA DE TAEKWONDO

Maša Kiš - 334

[SRB] KOLOSEUM

365 - Sofi Otasevic

[MKD] TKD KORIO - KISELA VODA

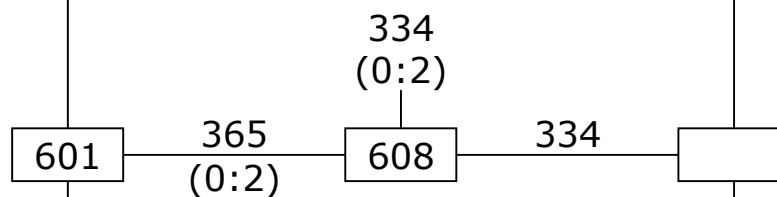

1. Maša Kiš ([SRB] KOLOSEUM)

2. Sofi Otasevic ([MKD] TKD KORIO - KISELA VODA)

3. Littasi Maria ([ROU] ASOCIATIA ROMANA DE TAE...

3.

15. Millennium Open
Competition Area 6
Pioniri B (6-7) F-25

2 competitors
2024-01-20

061 - Nera Paskaš
[SRB] EUROŠPED

193
(0:2)

609

Katarina Pešević - 193
[SRB] SPARTA

- | |
|------------------------------------|
| 1. Katarina Pešević ([SRB] SPARTA) |
| 2. Nera Paskaš ([SRB] EUROŠPED) |
| 3. |
| 3. |

15. Millennium Open Competition Area 6 Pioniri B (6-7) F-29

4 competitors
2024-01-20

280 - Milica Tošić
[SRB] EUROŠPED

Kalina Patrić - 278
[SRB] EUROŠPED

318 - Ekatarina Radosavljevic
[SRB] VRŠAC

Mia Jovanovik - 006
[MKD] TKD KORIO - KISELA VODA

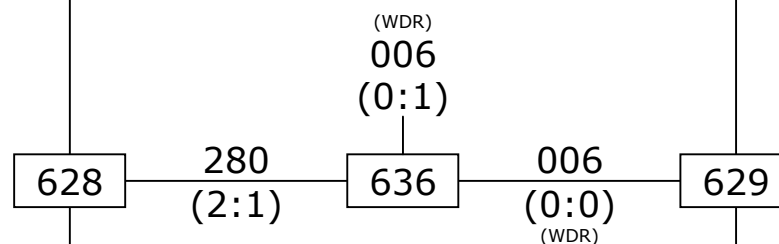

- | |
|--|
| 1. Mia Jovanovik ([MKD] TKD KORIO - KISELA VODA) |
| 2. Milica Tošić ([SRB] EUROŠPED) |
| 3. Kalina Patrić ([SRB] EUROŠPED) |
| 3. Ekatarina Radosavljevic ([SRB] VRŠAC) |

15. Millennium Open
Competition Area 6
Pioniri B (6-7) M-21

2 competitors
2024-01-20

257 - Lazar Dakic
[SRB] EUROŠPED

257
(2:0)

610

Mateo Lauric - 279
[SRB] EUROŠPED

1. Lazar Dakic ([SRB] EUROŠPED)
2. Mateo Lauric ([SRB] EUROŠPED)
3.
3.

15. Millennium Open
Competition Area 6
Pioniri B (6-7) M-23

2 competitors
2024-01-20

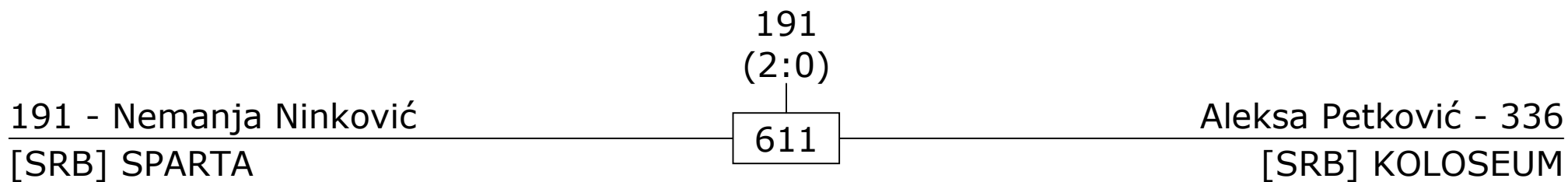

1. Nemanja Ninković ([SRB] SPARTA)
2. Aleksa Petković ([SRB] KOLOSEUM)
3.
3.

15. Millennium Open Competition Area 6 Pioniri B (6-7) M-25

4 competitors
2024-01-20

194 - Enil Kuačevci
[SRB] SPARTA

Aleksandar Ananijev - 281
[SRB] EUROŠPED

333 - Despot Čančarević
[SRB] IMPERIUM PAZOVA

Borna Todorovski - 367
[MKD] TKD KORIO - KISELA VODA

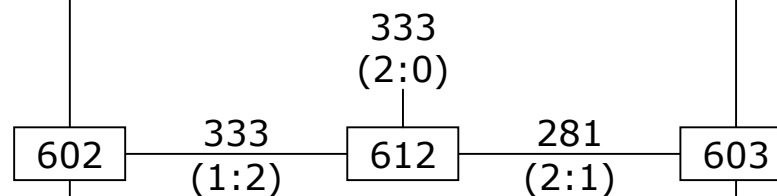

1. Despot Čančarević ([SRB] IMPERIUM PAZOVA)
2. Aleksandar Ananijev ([SRB] EUROŠPED)
3. Borna Todorovski ([MKD] TKD KORIO - KISELA V...)
3. Enil Kuačevci ([SRB] SPARTA)

15. Millennium Open
Competition Area 6
Pioniri B (6-7) M-27

2 competitors
2024-01-20

252 - Kosta Sudar
[SRB] ELIT

277
(1:2)

613

Marko Gava - 277
[SRB] EUROŠPED

1. Marko Gava ([SRB] EUROŠPED)

2. Kosta Sudar ([SRB] ELIT)

3.

3.

15. Millennium Open
Competition Area 6
Pioniri B (10-11) F-27

2 competitors
2024-01-20

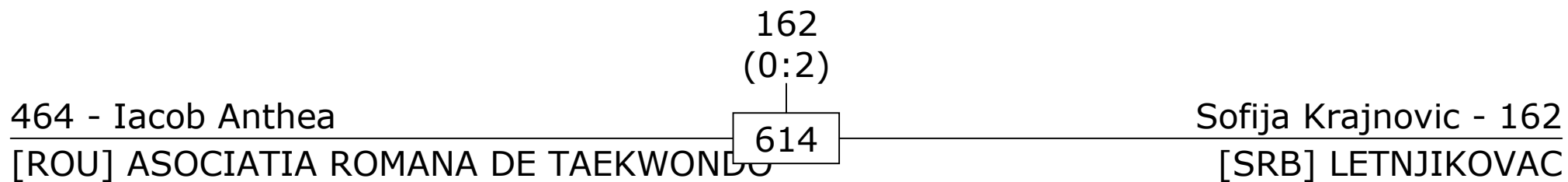

1. Sofija Krajnovic ([SRB] LETNJIKOVAC)
2. Iacob Anthea ([ROU] ASOCIATIA ROMANA DE TA...
3.
3.

15. Millennium Open Competition Area 6 Pioniri B (10-11) F-33

7 competitors
2024-01-20

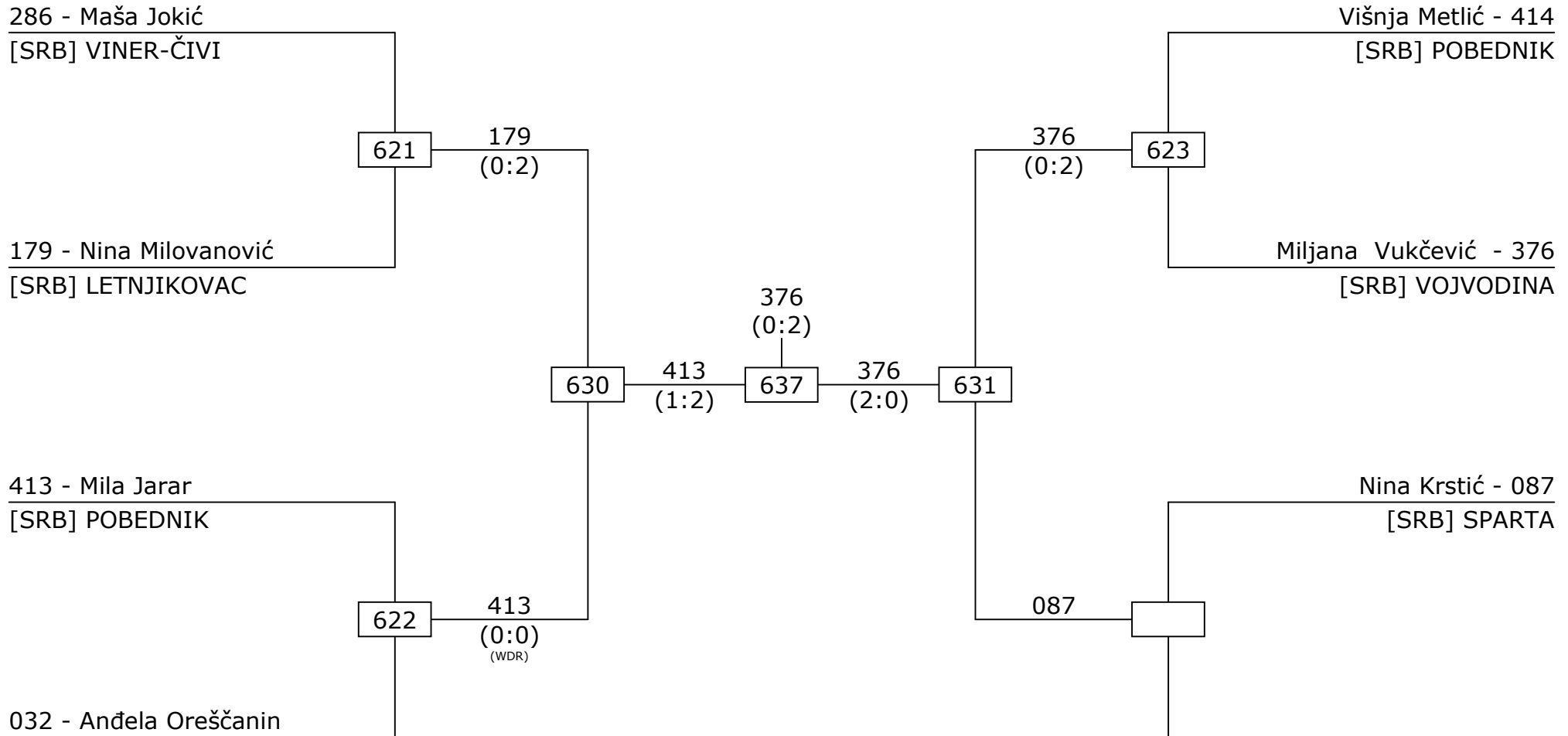

- | |
|---|
| 1. Miljana Vukčević ([SRB] VOJVODINA) |
| 2. Mila Jarar ([SRB] POBEDNIK) |
| 3. Nina Krstić ([SRB] SPARTA) |
| 3. Nina Milovanović ([SRB] LETNJIKOVAC) |

15. Millennium Open Competition Area 6 Pioniri B (10-11) F-36

6 competitors
2024-01-20

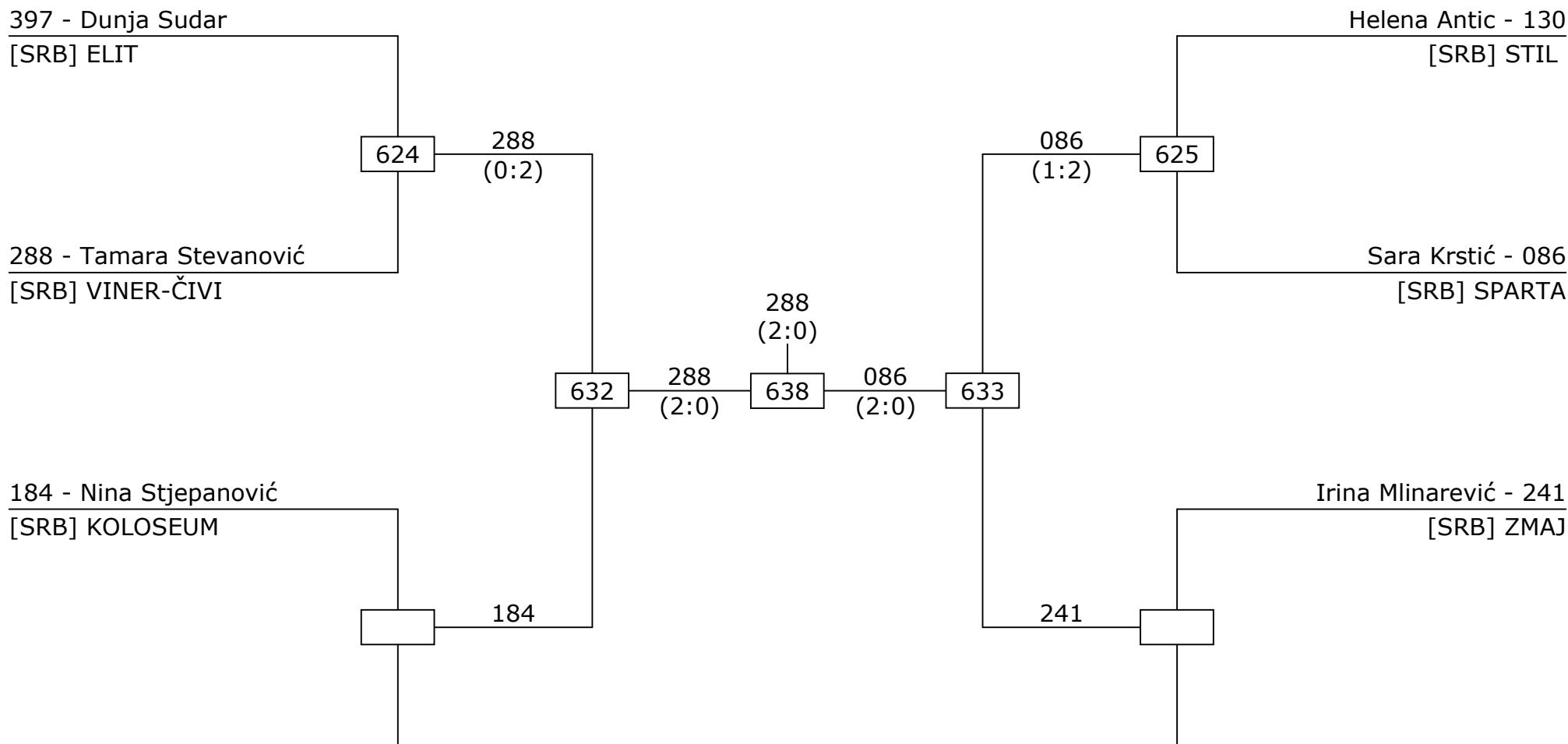

- | |
|---|
| 1. Tamara Stevanović ([SRB] VINER-ČIVI) |
| 2. Sara Krstić ([SRB] SPARTA) |
| 3. Irina Mlinarević ([SRB] ZMAJ) |
| 3. Nina Stjepanović ([SRB] KOLOSEUM) |

15. Millennium Open Competition Area 7 Pioniri B (10-11) F-40

6 competitors
2024-01-20

141 - Andrea Petković
[SRB] KOLOSEUM

186 - Una Vukanac
[SRB] SPARTA

017 - Tijana Dinčić
[SRB] POBEDNIK

Jovana Ivanović - 173
[SRB] LETNJKOVAC

Jovana Filipović - 062
[SRB] EUROŠPED

Nikolina Gavran - 412
[SRB] POBEDNIK

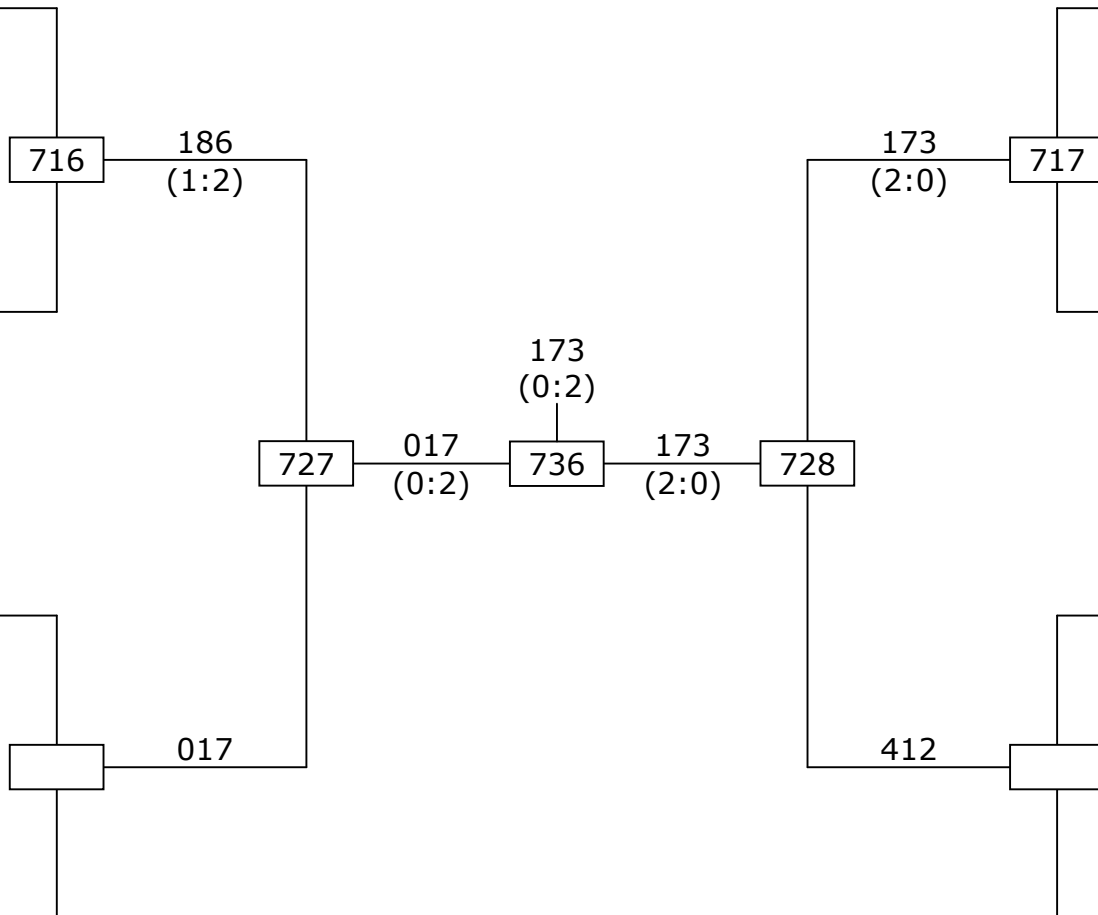

1. Jovana Ivanović ([SRB] LETNJKOVAC)
2. Tijana Dinčić ([SRB] POBEDNIK)
3. Nikolina Gavran ([SRB] POBEDNIK)
3. Una Vukanac ([SRB] SPARTA)

15. Millennium Open Competition Area 7 Pioniri B (10-11) F-44

6 competitors
2024-01-20

409 - Sara Novaković
[SRB] POBEDNIK

448 - Lea Birtič
[SLO] PANTAR

226 - Sofija Radić
[SRB] AZIJA

Ana Stojković - 027
[SRB] POBEDNIK

Tia Birtič - 449
[SLO] PANTAR

Tara Zec - 391
[SRB] VOJVODINA

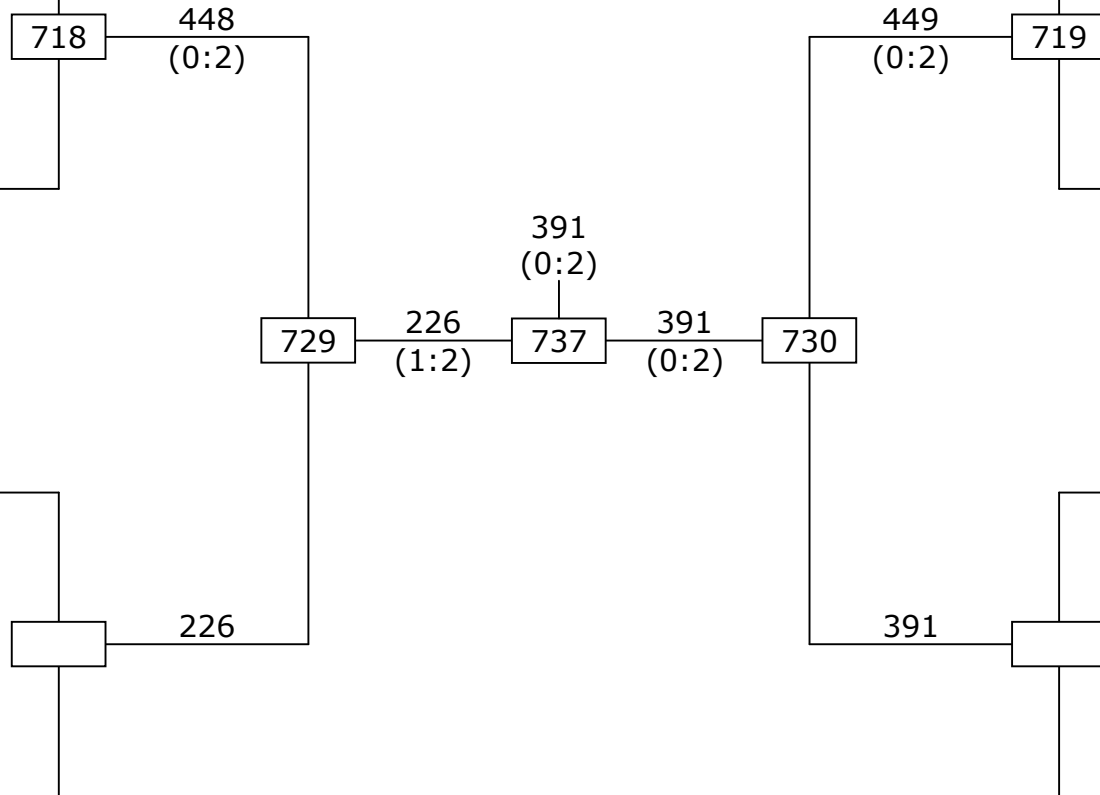

- | |
|-------------------------------|
| 1. Tara Zec ([SRB] VOJVODINA) |
| 2. Sofija Radić ([SRB] AZIJA) |
| 3. Tia Birtič ([SLO] PANTAR) |
| 3. Lea Birtič ([SLO] PANTAR) |

15. Millennium Open
Competition Area 6
Pioniri B (10-11) F-57

2 competitors
2024-01-20

058 - Anja Jurošević
[SRB] ZRENJANIN

058
(2:0)

656

Sofija Tišma - 018
[SRB] KWON BATAJNICA

1. Anja Jurošević ([SRB] ZRENJANIN)

2. Sofija Tišma ([SRB] KWON BATAJNICA)

3.

3.

15. Millennium Open
Competition Area 6
Pioniri B (10-11) M-27

2 competitors
2024-01-20

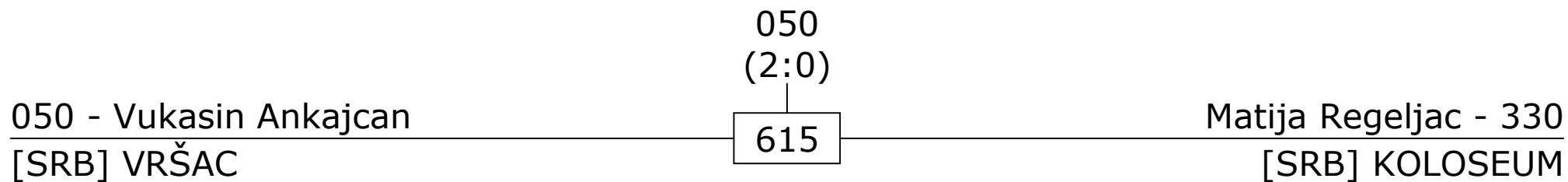

1. Vukasin Ankajcan ([SRB] VRŠAC)
2. Matija Regeljac ([SRB] KOLOSEUM)
3.
3.

15. Millennium Open Competition Area 6 Pioniri B (10-11) M-30

6 competitors
2024-01-20

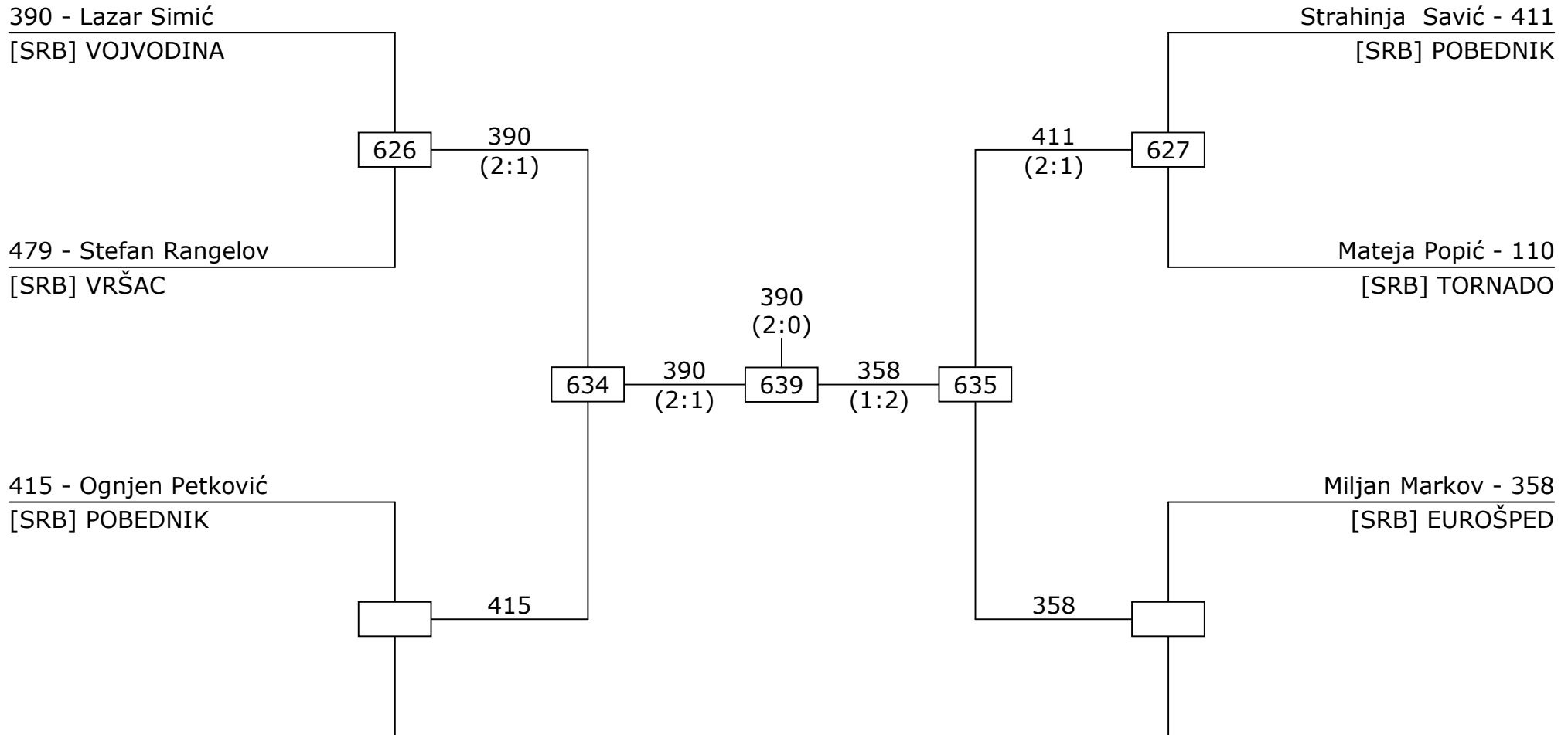

1. Lazar Simić ([SRB] VOJVODINA)
2. Miljan Markov ([SRB] EUROŠPED)
3. Strahinja Savić ([SRB] POBEDNIK)
3. Ognjen Petković ([SRB] POBEDNIK)

15. Millennium Open
Competition Area 6
Pioniri B (10-11) M-33

3 competitors
2024-01-20

453 - Matic Birtič
[SLO] PANTAR

Marcell Salamon - 429
[HUN] TAEKWONDO FANATIX

258 - Branimir Sabo
[SRB] EUROŠPED

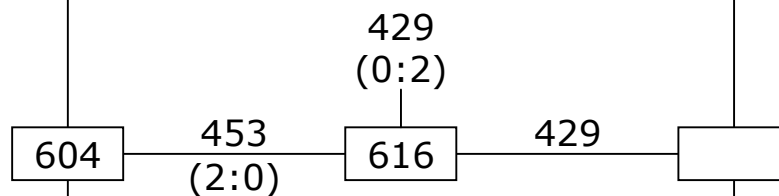

- | |
|--|
| 1. Marcell Salamon ([HUN] TAEKWONDO FANATIX) |
| 2. Matic Birtič ([SLO] PANTAR) |
| 3. Branimir Sabo ([SRB] EUROŠPED) |
| 3. |

15. Millennium Open
Competition Area 6
Pioniri B (10-11) M-36

3 competitors
2024-01-20

410 - Kosta Vojinović
[SRB] POBEDNIK

David Pavlović - 147
[SRB] ASTRA-NIŠ

458 - Bor Poglajen
[SLO] PANTAR

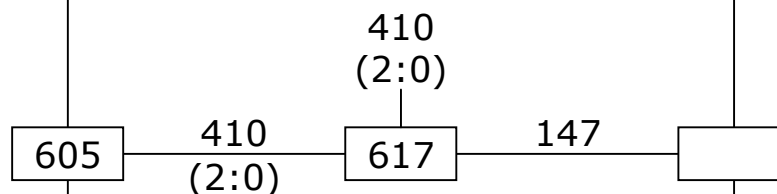

- | |
|-------------------------------------|
| 1. Kosta Vojinović ([SRB] POBEDNIK) |
| 2. David Pavlović ([SRB] ASTRA-NIŠ) |
| 3. Bor Poglajen ([SLO] PANTAR) |
| 3. |

15. Millennium Open Competition Area 7 Pioniri B (10-11) M-40

8 competitors
2024-01-20

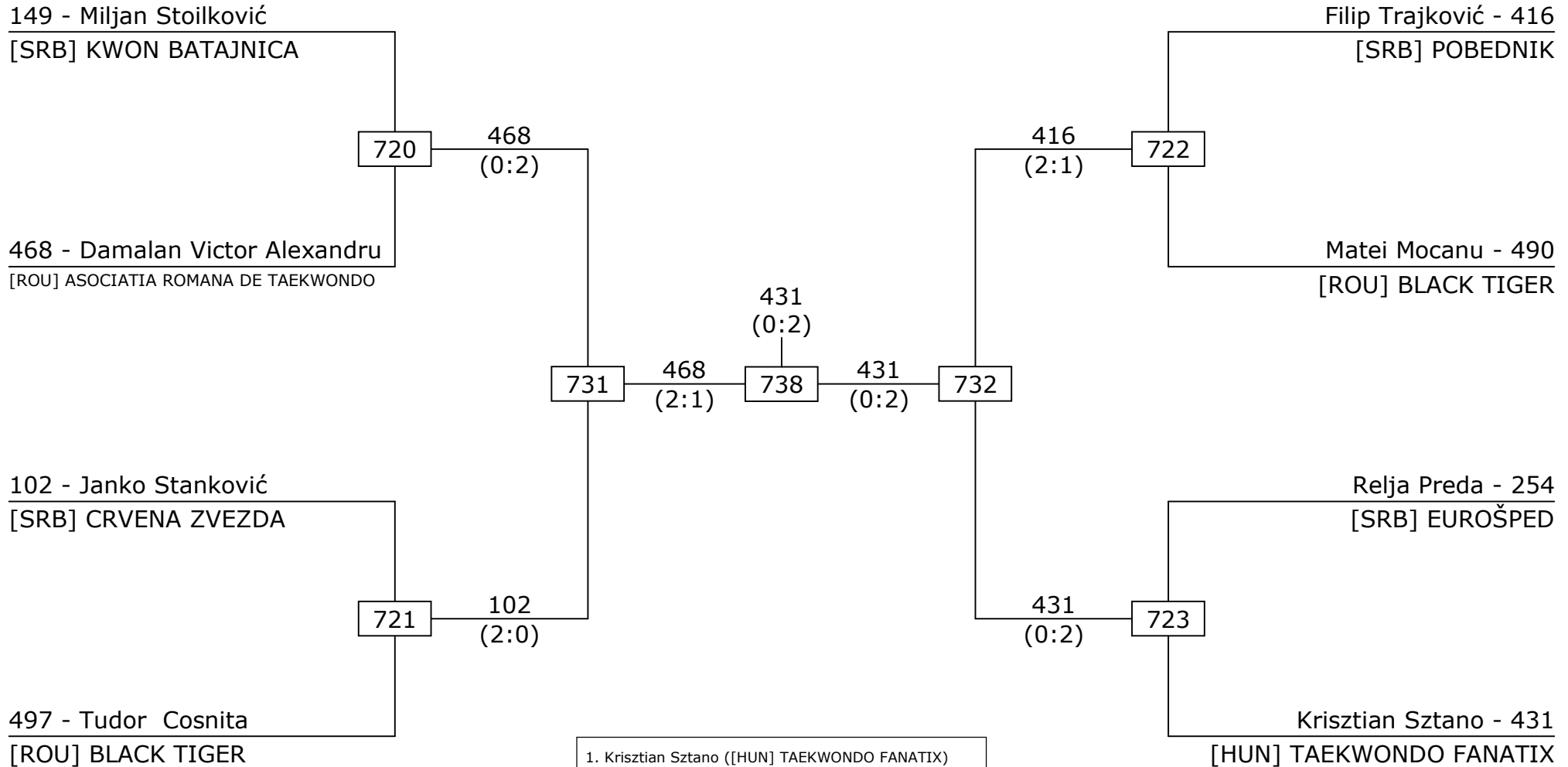

- | |
|---|
| 1. Krisztian Sztano ([HUN] TAEKWONDO FANATIX) |
| 2. Damalan Victor Alexandru ([ROU] ASOCIATIA RO...) |
| 3. Filip Trajković ([SRB] POBEDNIK) |
| 3. Janko Stanković ([SRB] CRVENA ZVEZDA) |

15. Millennium Open Competition Area 7 Pioniri B (10-11) M-44

7 competitors
2024-01-20

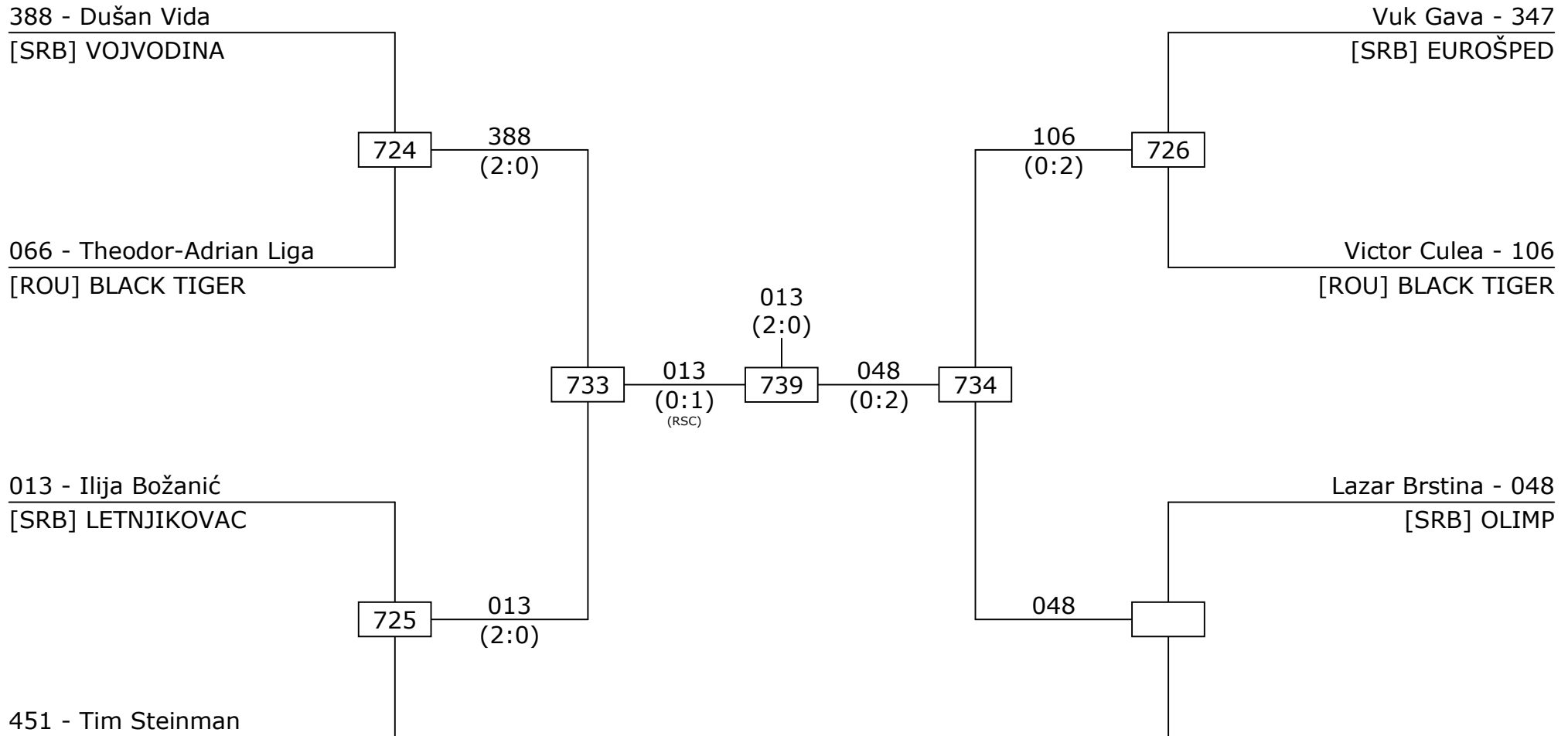

- | |
|-------------------------------------|
| 1. Ilija Božanić ([SRB] LETNJKOVAC) |
| 2. Lazar Brstina ([SRB] OLIMP) |
| 3. Victor Culea ([ROU] BLACK TIGER) |
| 3. Dušan Vida ([SRB] VOJVODINA) |

15. Millennium Open
Competition Area 7
Pioniri B (10-11) M-48

2 competitors
2024-01-20

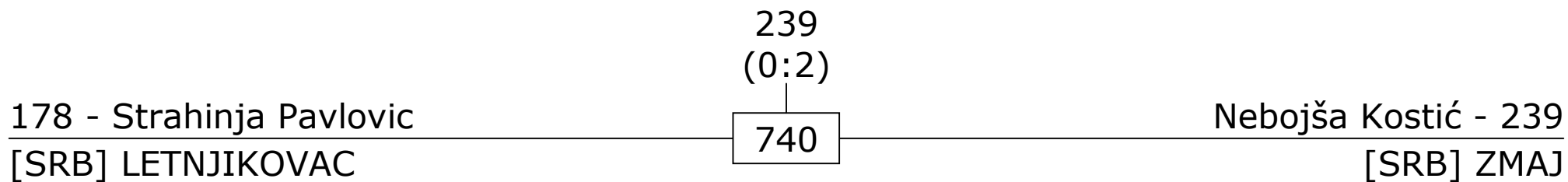

1. Nebojša Kostić ([SRB] ZMAJ)
2. Strahinja Pavlovic ([SRB] LETNJKOVAC)
3.
3.

15. Millennium Open Competition Area 6 Pioniri A (8-9) F-23

3 competitors
2024-01-20

044 - Bjanka Kaličanin
[SRB] OBELIX

Sofija Kaćanski - 180
[SRB] HERKULES

314 - Maša Andreevska
[SRB] GITROS

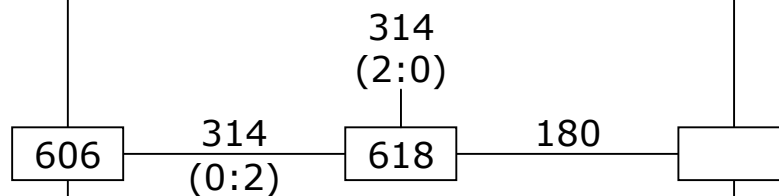

- | |
|-------------------------------------|
| 1. Maša Andreevska ([SRB] GITROS) |
| 2. Sofija Kaćanski ([SRB] HERKULES) |
| 3. Bjanka Kaličanin ([SRB] OBELIX) |
| 3. |

15. Millennium Open Competition Area 1 Pioniri A (8-9) F-29

3 competitors
2024-01-20

275 - Sofija Stamenkovic
[SRB] ASTERIKS

Petra Babić - 305
[SRB] HERKULES

210 - Sofija Jokic
[SRB] KWON BATAJNICA

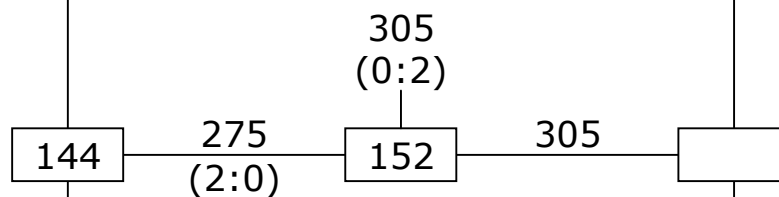

1. Petra Babić ([SRB] HERKULES)

2. Sofija Stamenkovic ([SRB] ASTERIKS)

3. Sofija Jokic ([SRB] KWON BATAJNICA)

3.

15. Millennium Open
Competition Area 1
Pioniri A (8-9) F-31

2 competitors
2024-01-20

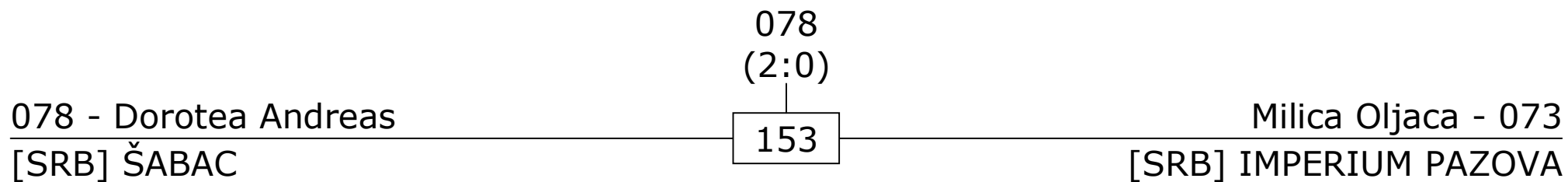

1. Dorotea Andreas ([SRB] ŠABAC)
2. Milica Oljaca ([SRB] IMPERIUM PAZOVA)
3.
3.

15. Millennium Open Competition Area 1 Pioniri A (8-9) F-33

3 competitors
2024-01-20

524 - Kalina Tasić
[SRB] ASTERIKS

Maša Subotić - 402
[SRB] ELIT

435 - Teodora Petrović
[SRB] NAISUS

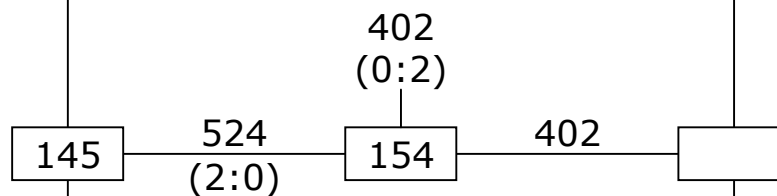

- | |
|------------------------------------|
| 1. Maša Subotić ([SRB] ELIT) |
| 2. Kalina Tasić ([SRB] ASTERIKS) |
| 3. Teodora Petrović ([SRB] NAISUS) |
| 3. |

15. Millennium Open
Competition Area 3
Pioniri A (8-9) F-39

2 competitors
2024-01-20

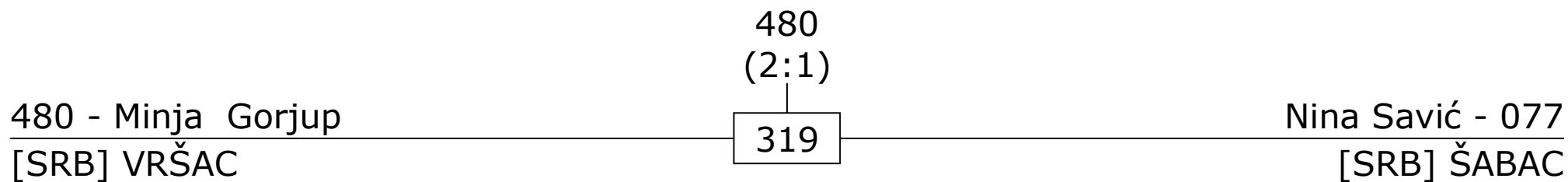

1. Minja Gorjup ([SRB] VRŠAC)
2. Nina Savić ([SRB] ŠABAC)
3.
3.

15. Millennium Open
Competition Area 1
Pioniri A (8-9) M-23

2 competitors
2024-01-20

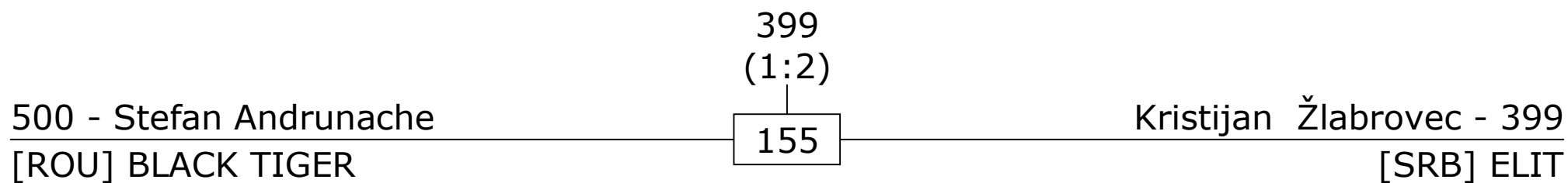

1. Kristijan Žlabrovec ([SRB] ELIT)
2. Stefan Andrunache ([ROU] BLACK TIGER)
3.
3.

15. Millennium Open Competition Area 1 Pioniri A (8-9) M-25

5 competitors
2024-01-20

301 - Filip Džalev
[SRB] HERKULES

368 - Lazar Filic
[MKD] TKD KORIO - KISELA VODA

440 - Danijel Žlabrovec
[SRB] ELIT

Relja Jovanović - 298
[SRB] OBRENOVAC

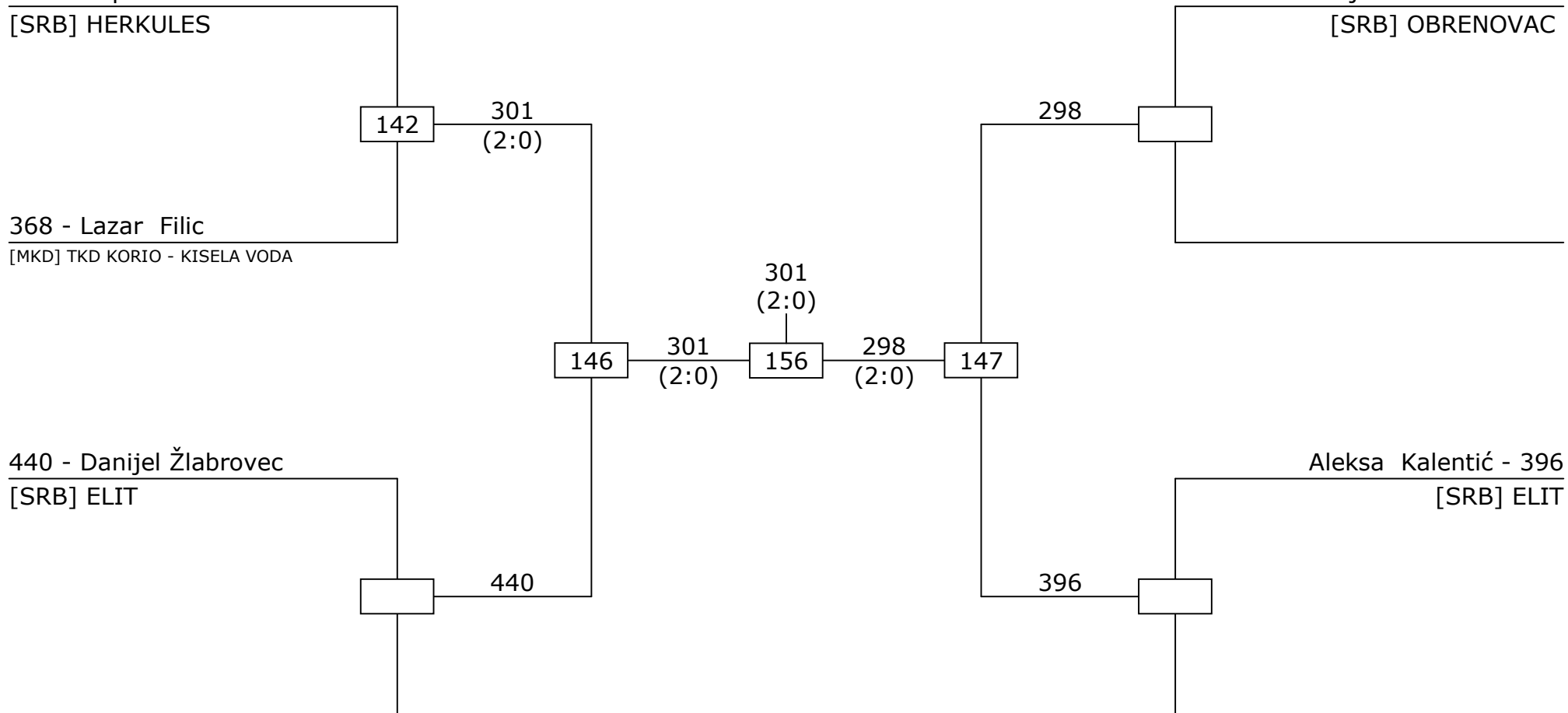

- | |
|---------------------------------------|
| 1. Filip Džalev ([SRB] HERKULES) |
| 2. Relja Jovanović ([SRB] OBRENOVAC) |
| 3. Aleksa Kalentić ([SRB] ELIT) |
| 3. Danijel Žlabrovec ([SRB] ELIT) |

15. Millennium Open Competition Area 1 Pioniri A (8-9) M-27

4 competitors
2024-01-20

113 - Luka Lazović
[SRB] TORNADO

Teodor Ostojeć - 348
[SRB] EUROŠPED

134 - Pavle Jovanovic
[SRB] LETNJKOVAC

Aron Rouaj - 517
[ROU] BLACK TIGER

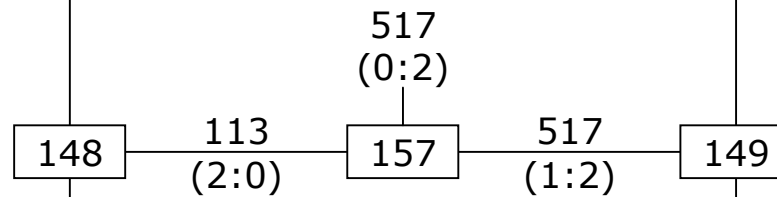

- | |
|---------------------------------------|
| 1. Aron Rouaj ([ROU] BLACK TIGER) |
| 2. Luka Lazović ([SRB] TORNADO) |
| 3. Teodor Ostojeć ([SRB] EUROŠPED) |
| 3. Pavle Jovanovic ([SRB] LETNJKOVAC) |

15. Millennium Open
Competition Area 1
Pioniri A (8-9) M-29

2 competitors
2024-01-20

434 - Jakov Zazić
[SRB] NAISUS

229
(1:2)

158

Pavle Marić - 229
[SRB] AZIJA

- | |
|-------------------------------|
| 1. Pavle Marić ([SRB] AZIJA) |
| 2. Jakov Zazić ([SRB] NAISUS) |
| 3. |
| 3. |

15. Millennium Open
Competition Area 1
Pioniri A (8-9) M-31

2 competitors
2024-01-20

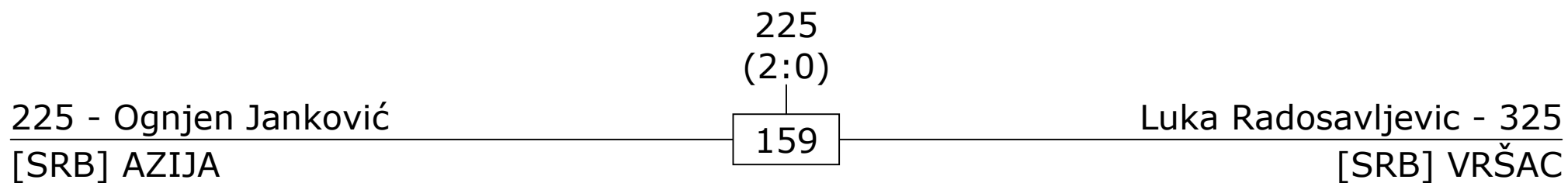

1. Ognjen Janković ([SRB] AZIJA)
2. Luka Radosavljevic ([SRB] VRŠAC)
3.
3.

15. Millennium Open Competition Area 1 Pioniri A (10-11) F-27

5 competitors
2024-01-20

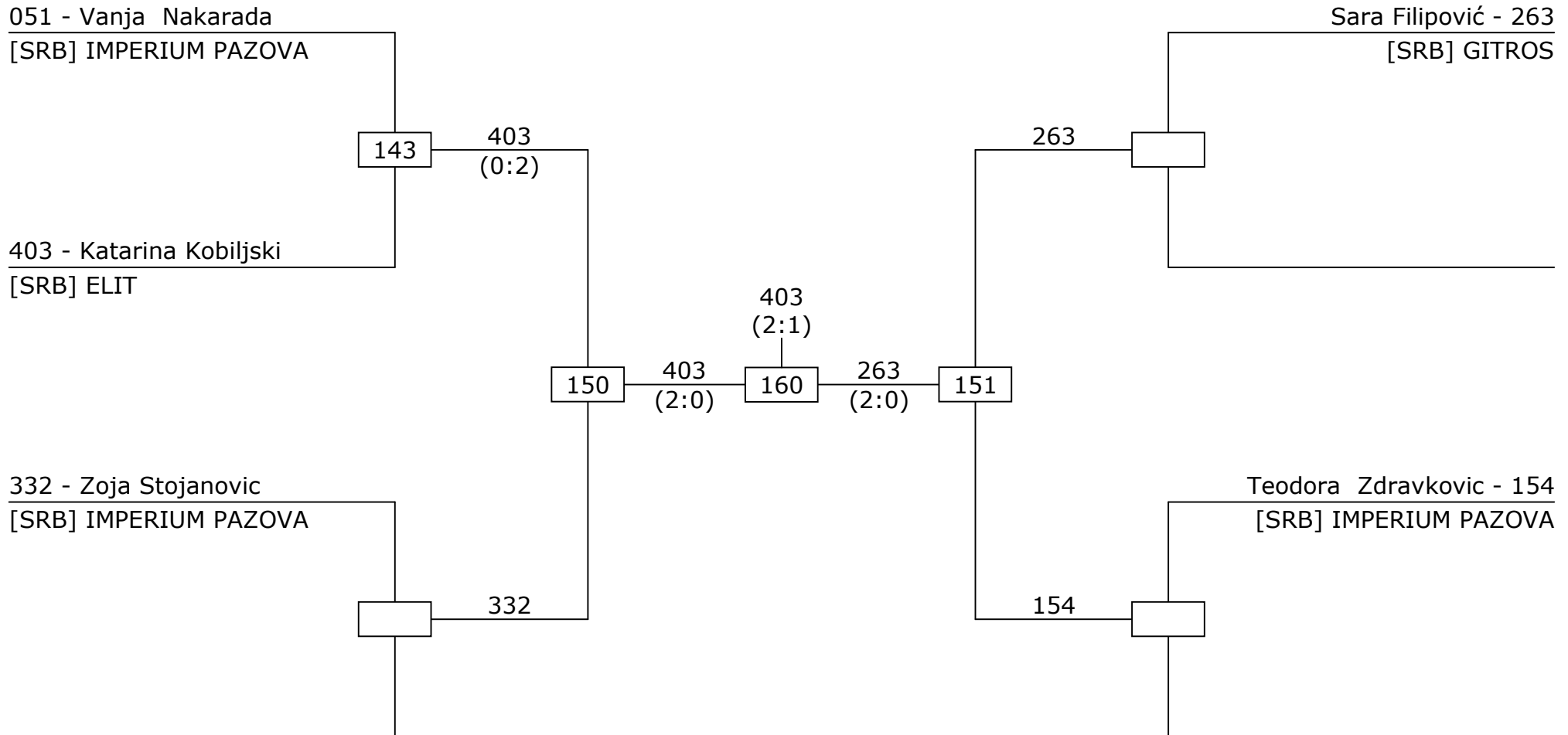

- | |
|---|
| 1. Katarina Kobiljski ([SRB] ELIT) |
| 2. Sara Filipović ([SRB] GITROS) |
| 3. Teodora Zdravkovic ([SRB] IMPERIUM PAZOVA) |
| 3. Zoja Stojanovic ([SRB] IMPERIUM PAZOVA) |

15. Millennium Open Competition Area 1 Pioniri A (10-11) F-30

12 competitors
2024-01-20

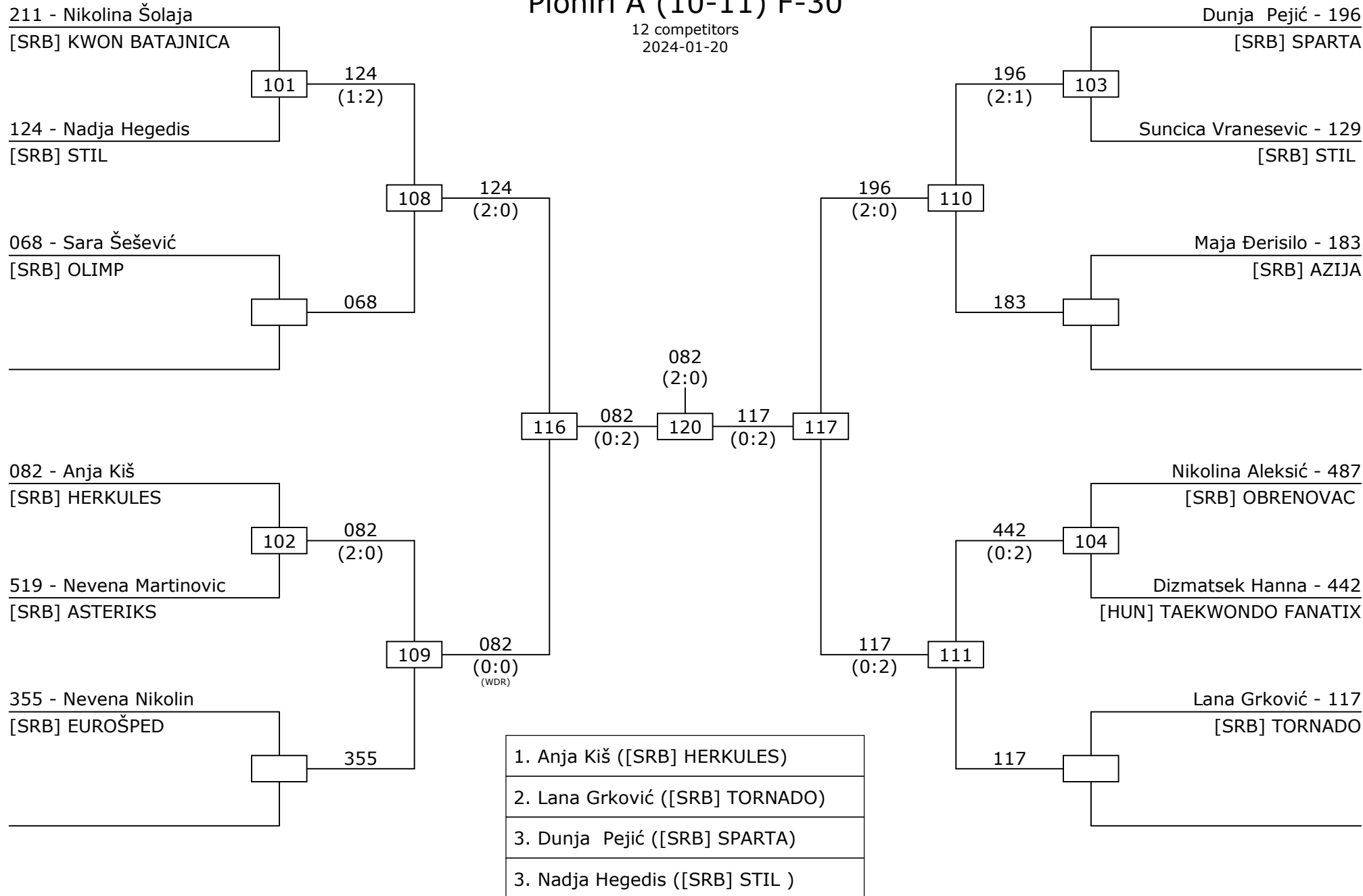

15. Millennium Open Competition Area 1 Pioniri A (10-11) F-33

9 competitors
2024-01-20

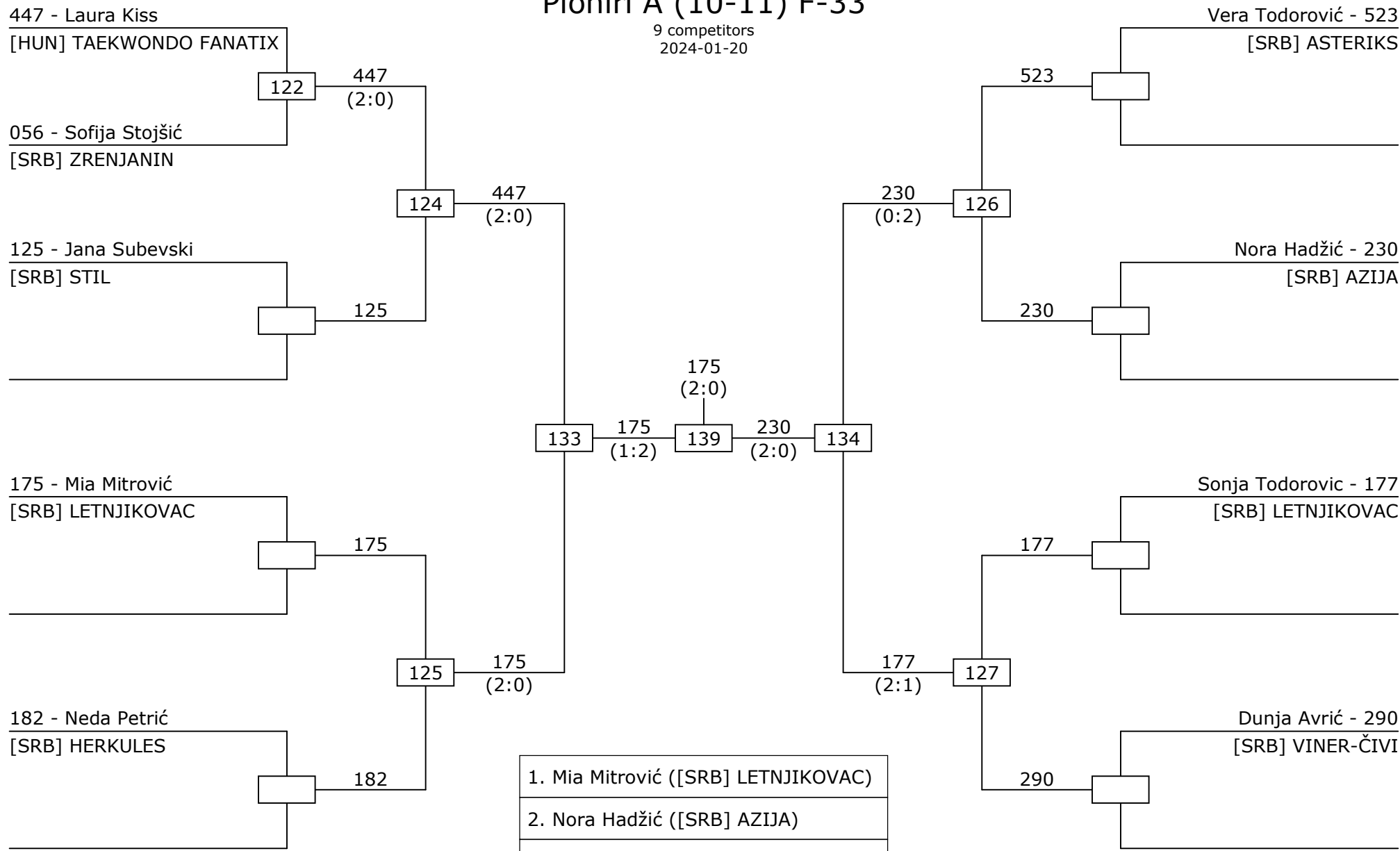

- | |
|---|
| 1. Mia Mitrović ([SRB] LETNJKOVAC) |
| 2. Nora Hadžić ([SRB] AZIJA) |
| 3. Sonja Todorovic ([SRB] LETNJKOVAC) |
| 3. Laura Kiss ([HUN] TAEKWONDO FANATIX) |

15. Millennium Open Competition Area 1 Pioniri A (10-11) F-36

9 competitors
2024-01-20

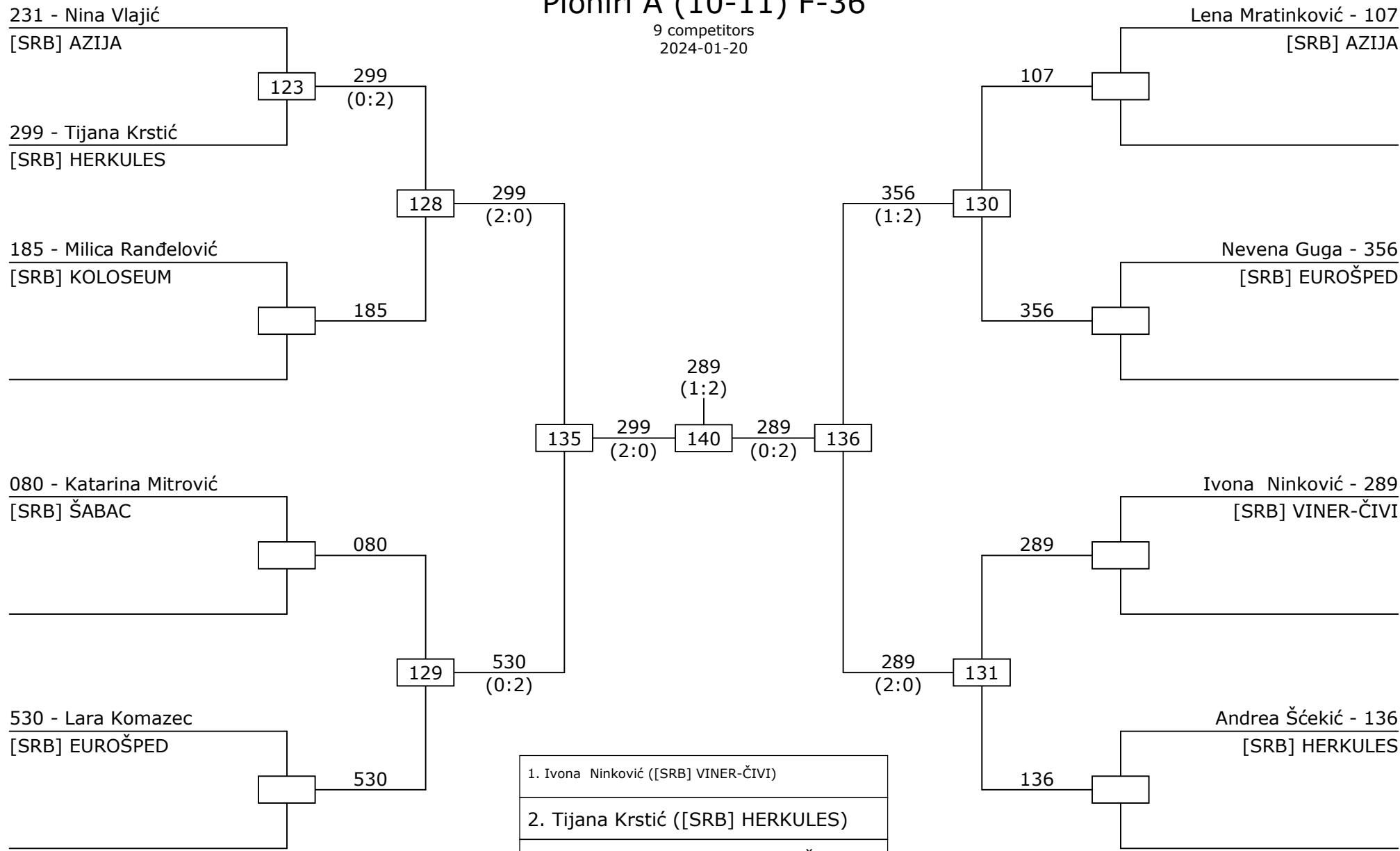

- | |
|--------------------------------------|
| 1. Ivona Ninković ([SRB] VINER-ČIVI) |
| 2. Tijana Krstić ([SRB] HERKULES) |
| 3. Nevena Guga ([SRB] EUROŠPED) |
| 3. Lara Komazec ([SRB] EUROŠPED) |

15. Millennium Open Competition Area 3 Pioniri A (10-11) F-40

8 competitors
2024-01-20

145 - Kristina Vidojkovic
[SRB] ASTRA-NIŠ

233 - Simona Plamenac
[SRB] AZIJA

439 - Mila Stankovic
[SRB] ASTERIKS

096 - Milica Đurić
[SRB] OLIMP

Natalija Lučić - 302
[SRB] HERKULES

Milica Mitrović - 079
[SRB] ŠABAC

Jovana Vujčić - 398
[SRB] ELIT

Daria Guzu - 204
[ROU] BLACK TIGER

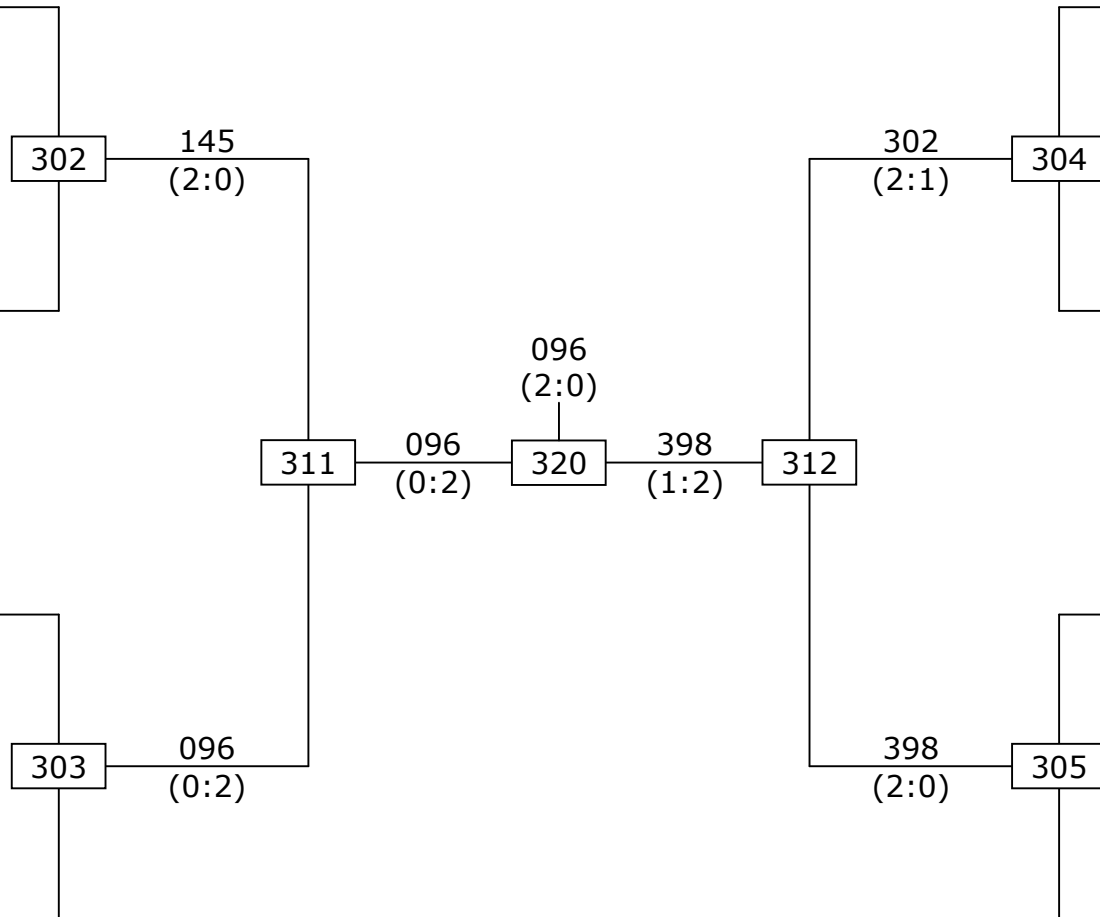

- | |
|--|
| 1. Milica Đurić ([SRB] OLIMP) |
| 2. Jovana Vujčić ([SRB] ELIT) |
| 3. Natalija Lučić ([SRB] HERKULES) |
| 3. Kristina Vidojkovic ([SRB] ASTRA-NIŠ) |

15. Millennium Open
Competition Area 4
Pioniri A (10-11) F+57

3 competitors
2024-01-20

292 - Sara Mirić
[SRB] ŠAMPION

Jovana Trivkovic - 011
[SRB] KWON BATAJNICA

008 - Danka Matić
[SRB] HERKULES

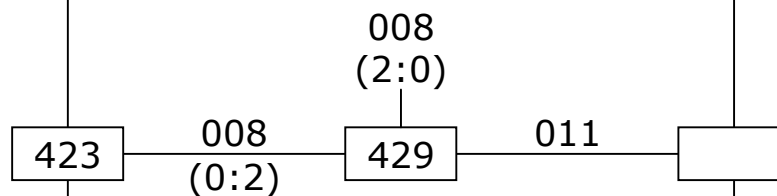

1. Danka Matić ([SRB] HERKULES)

2. Jovana Trivkovic ([SRB] KWON BATAJNICA)

3. Sara Mirić ([SRB] ŠAMPION)

3.

15. Millennium Open
Competition Area 1
Pioniri A (10-11) M-27

2 competitors
2024-01-20

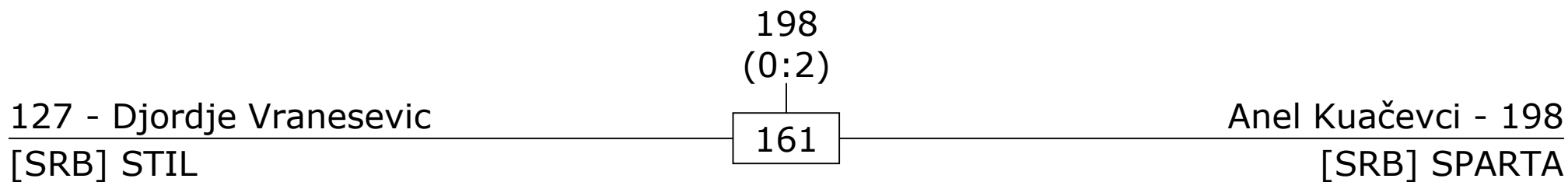

1. Anel Kuačevci ([SRB] SPARTA)
2. Djordje Vranesevic ([SRB] STIL)
3.
3.

15. Millennium Open Competition Area 1 Pioniri A (10-11) M-30

5 competitors
2024-01-20

246 - Rares-Marian Bortos
[ROU] BLACK TIGER

485 - Andrej Timarac
[BIH] LJUBIJA-PRIJEDOR

223 - Vanja Dobriković
[SRB] AZIJA

Aleksandar Kovač - 114
[SRB] TORNADO

Mihailo Milojević - 037
[SRB] ZMAJ

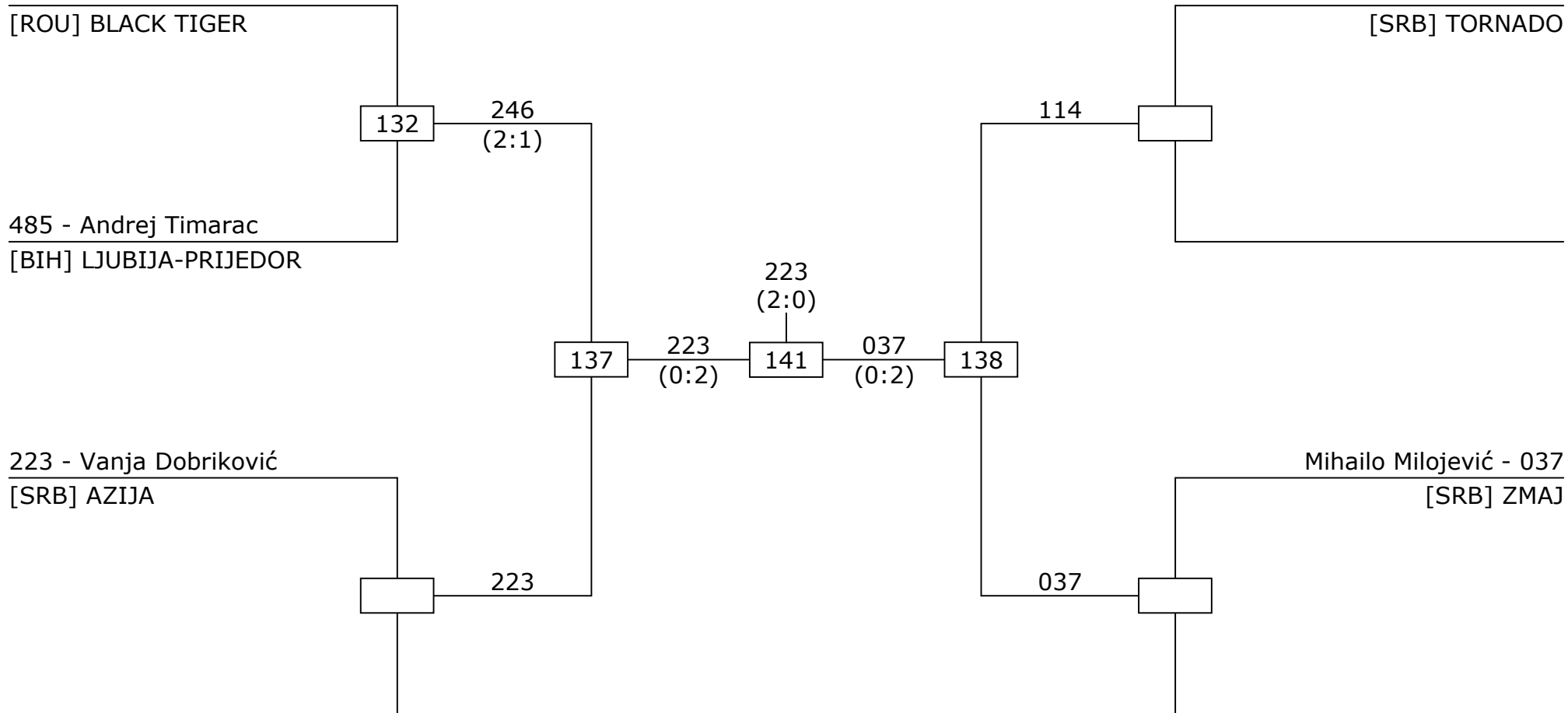

- | |
|--|
| 1. Vanja Dobriković ([SRB] AZIJA) |
| 2. Mihailo Milojević ([SRB] ZMAJ) |
| 3. Aleksandar Kovač ([SRB] TORNADO) |
| 3. Rares-Marian Bortos ([ROU] BLACK TIGER) |

15. Millennium Open Competition Area 1 Pioniri A (10-11) M-33

11 competitors
2024-01-20

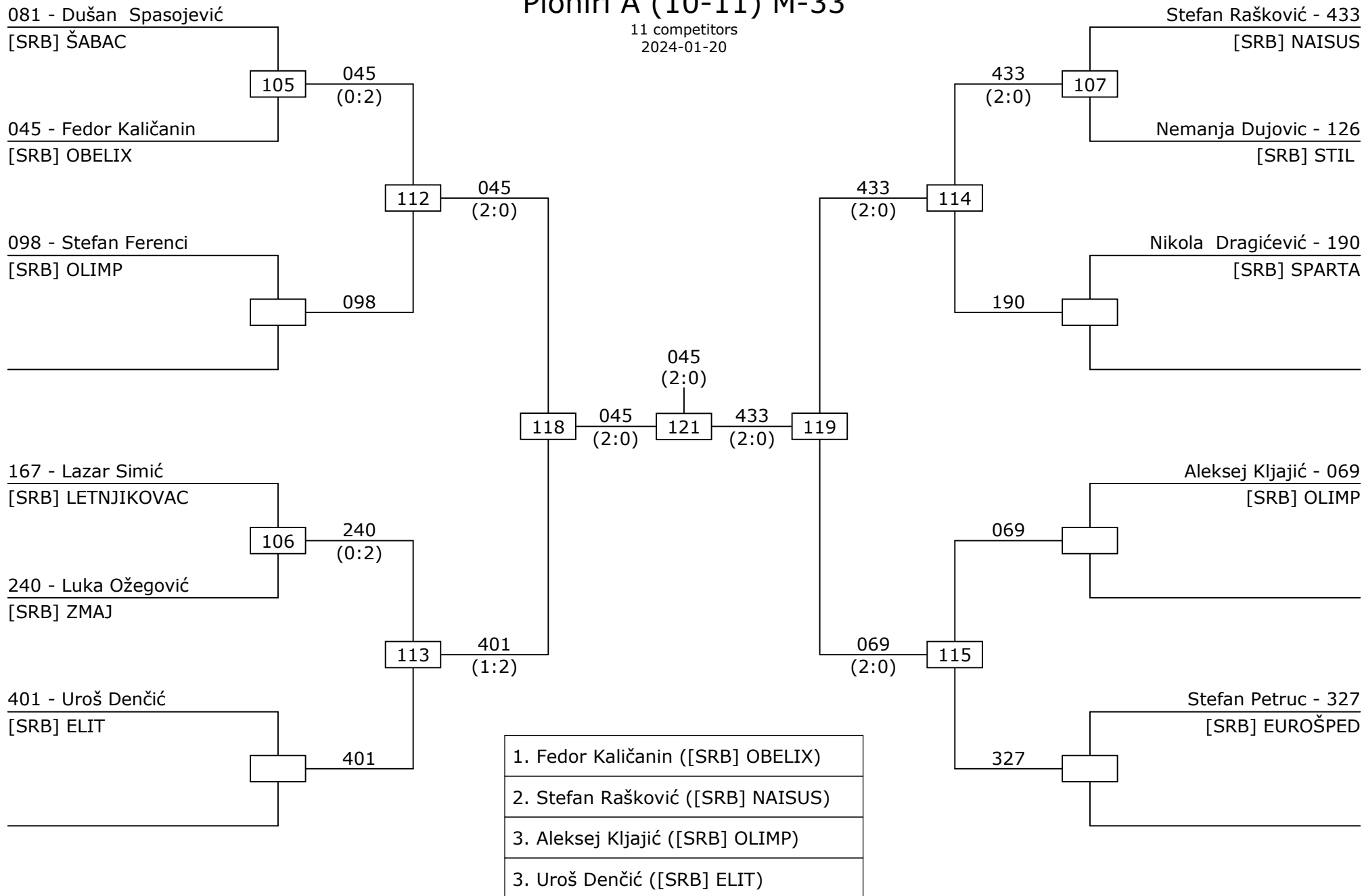

15. Millennium Open
Competition Area 3
Pioniri A (10-11) M-40

4 competitors
2024-01-20

203 - Nikola Šopić
[SRB] AZIJA

David Milankovic - 090
[SRB] SPARTA

526 - Nikola Jovulov
[SRB] EUROŠPED

Veljko Ristić - 043
[SRB] NAISUS

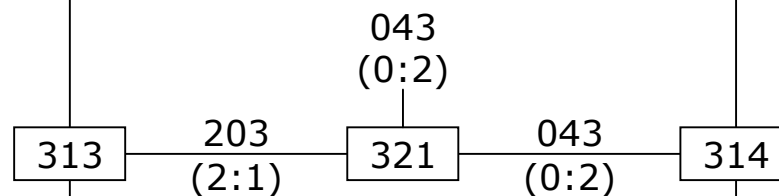

- | |
|------------------------------------|
| 1. Veljko Ristić ([SRB] NAISUS) |
| 2. Nikola Šopić ([SRB] AZIJA) |
| 3. David Milankovic ([SRB] SPARTA) |
| 3. Nikola Jovulov ([SRB] EUROŠPED) |

15. Millennium Open
Competition Area 4
Pioniri A (10-11) M+57

2 competitors
2024-01-20

157 - Vidan Klasnja
[SRB] EUROŠPED

459
(0:2)

430

Njegoš Jeličić - 459
[BIH] LJUBIJA-PRIJEDOR

1. Njegoš Jeličić ([BIH] LJUBIJA-PRIJEDOR)
2. Vidan Klasnja ([SRB] EUROŠPED)
3.
3.

15. Millennium Open
Competition Area 7
Kadet B F-41

2 competitors
2024-01-20

016 - Ana Darija Jovanović
[SRB] CRVENA ZVEZDA

003
(1:2)

756

Takacs Patricia - 003
[ROU] ASOCIATIA ROMANA DE TAEKWONDO

1. Takacs Patricia ([ROU] ASOCIATIA ROMANA DE T...
2. Ana Darija Jovanović ([SRB] CRVENA ZVEZDA)
3.
3.

15. Millennium Open Competition Area 7 Kadet B F-44

8 competitors
2024-01-20

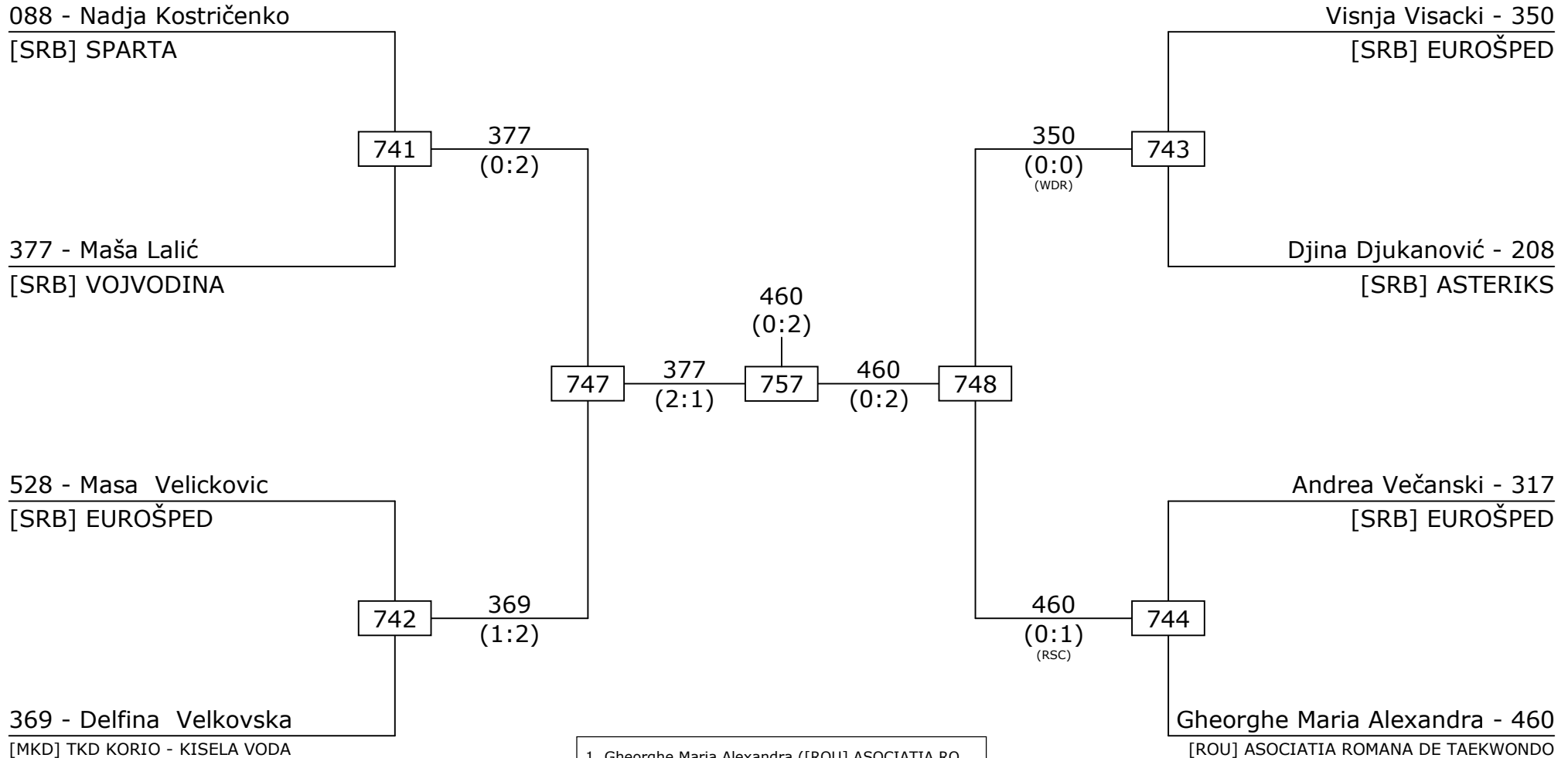

- | |
|---|
| 1. Gheorghe Maria Alexandra ([ROU] ASOCIATIA RO... |
| 2. Maša Lalić ([SRB] VOJVODINA) |
| 3. Visnja Visacki ([SRB] EUROŠPED) |
| 3. Delfina Velkovska ([MKD] TKD KORIO - KISELA V... |

15. Millennium Open Competition Area 7 Kadet B F-47

4 competitors
2024-01-20

166 - Helena Santrac
[SRB] LETNJIKOVAC

Mina Mičić - 131

[SRB] OMEGA-BEOGRAD

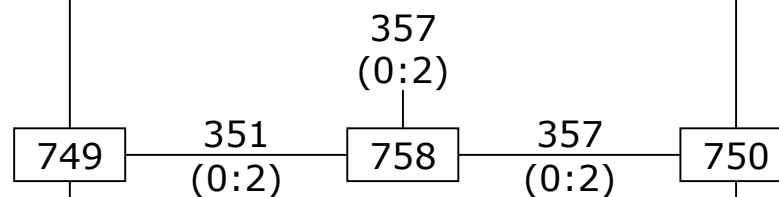

351 - Valentina Marjan
[SRB] EUROŠPED

Natasa Vuletic - 357
[SRB] EUROŠPED

- | |
|---------------------------------------|
| 1. Natasa Vuletic ([SRB] EUROŠPED) |
| 2. Valentina Marjan ([SRB] EUROŠPED) |
| 3. Mina Mičić ([SRB] OMEGA-BEOGRAD) |
| 3. Helena Santrac ([SRB] LETNJIKOVAC) |

15. Millennium Open Competition Area 7 Kadet B F-51

6 competitors
2024-01-20

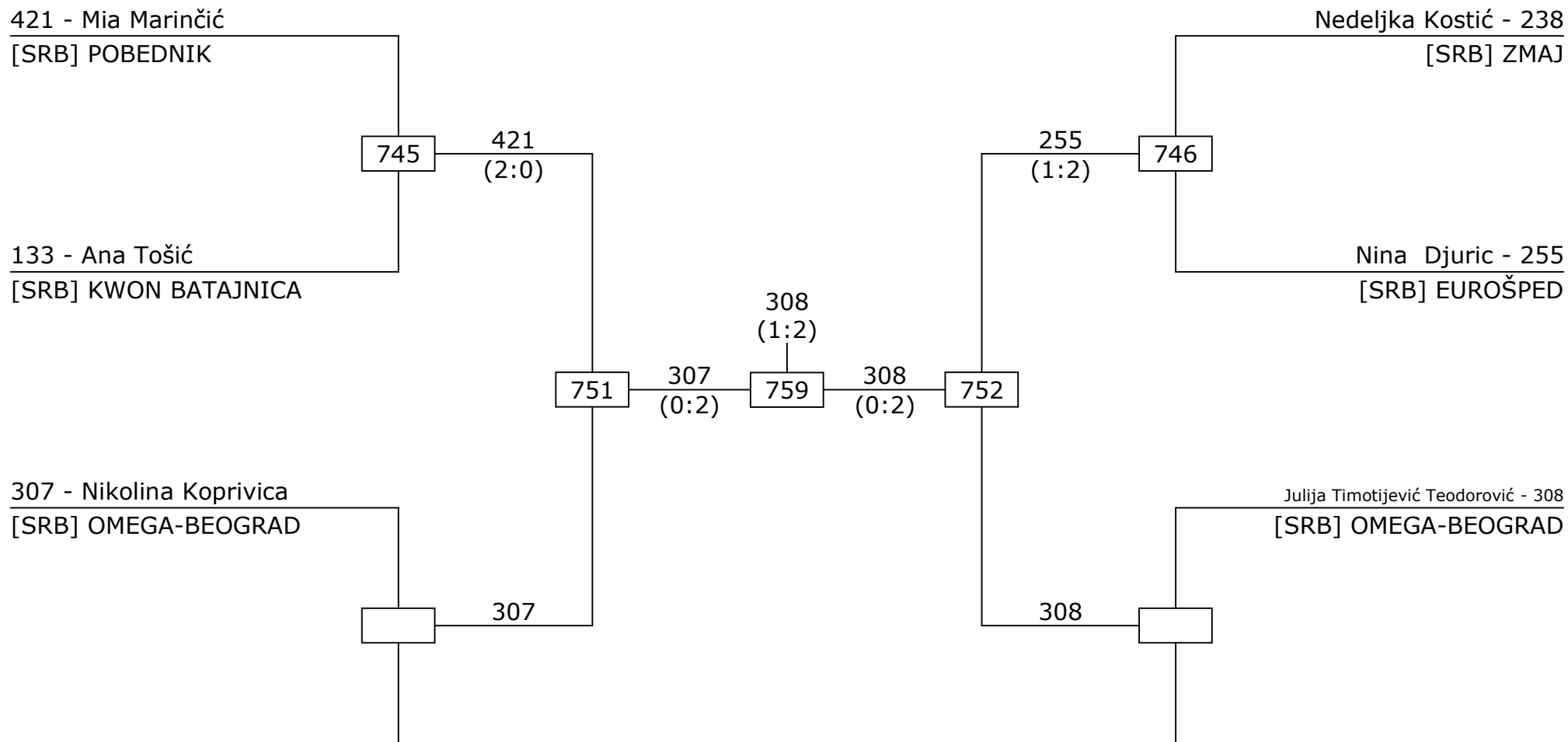

- | |
|--|
| 1. Julija Timotijević Teodorović ([SRB] OMEGA-BEO... |
| 2. Nikolina Koprivica ([SRB] OMEGA-BEOGRAD) |
| 3. Nina Djuric ([SRB] EUROŠPED) |
| 3. Mia Marinčić ([SRB] POBEDNIK) |

15. Millennium Open Competition Area 6 Kadet B F-55

6 competitors
2024-01-20

470 - Zirbo Roman Amalia

[ROU] ASOCIATIA ROMANA DE TAEKWONDO

640 — 104
(1:2)

104 - Anđelija Jovanović

[SRB] CRVENA ZVEZDA

420 - Ana Marija Vučinić

[SRB] POBEDNIK

420

645 — 104
(2:0) — 657 — 039
(1:2) — 646

039
(0:2)

132
(2:0) — 641

Una Andonović - 132

[SRB] KWON BATAJNICA

Frosina Belevska - 372

[MKD] TKD KORIO - KISELA VODA

Valentina Trajković - 039

[SRB] FENIKS

039

1. Valentina Trajković ([SRB] FENIKS)
2. Anđelija Jovanović ([SRB] CRVENA ZVEZDA)
3. Una Andonović ([SRB] KWON BATAJNICA)
3. Ana Marija Vučinić ([SRB] POBEDNIK)

15. Millennium Open Competition Area 6 Kadet B F-59

5 competitors
2024-01-20

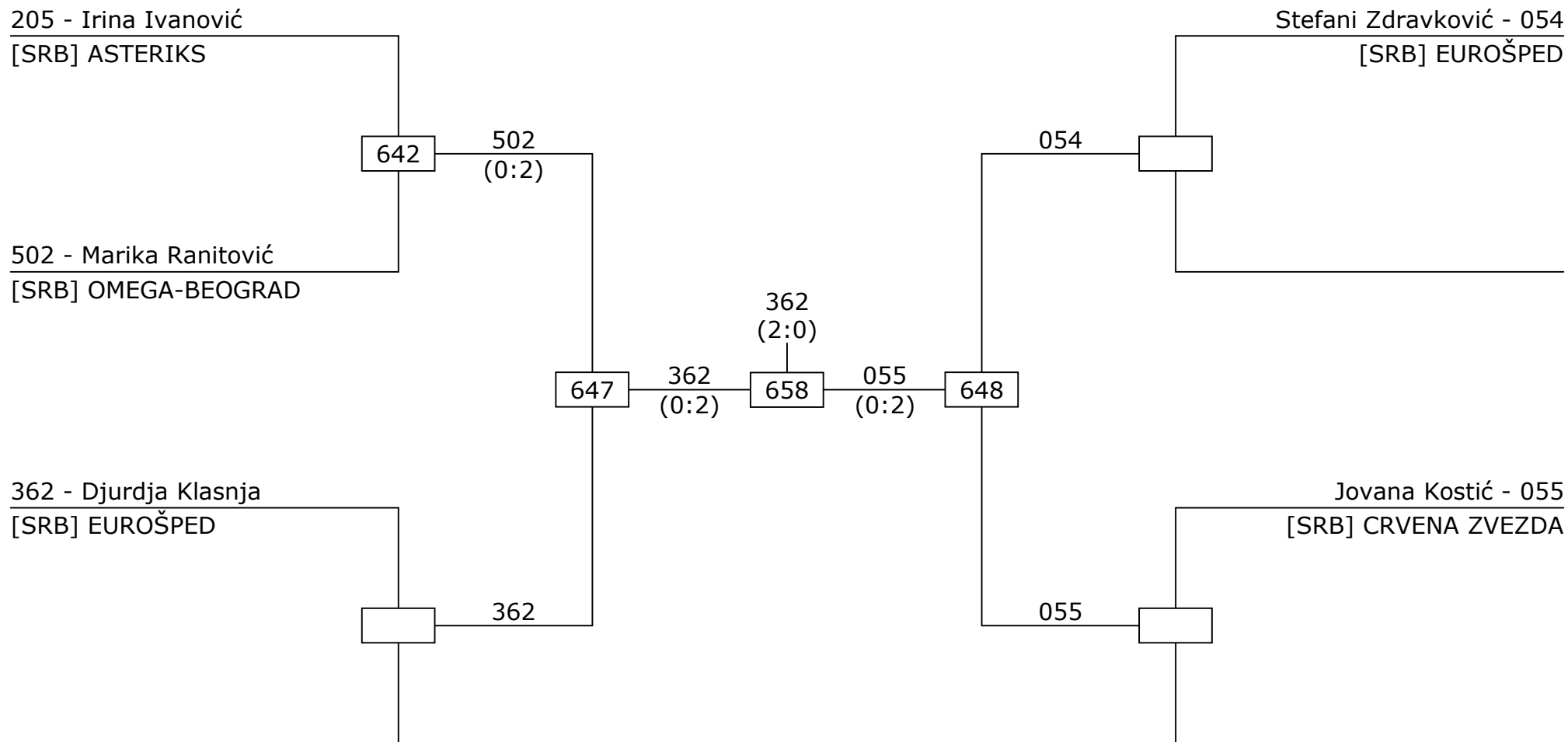

- | |
|---|
| 1. Djurdja Klasnja ([SRB] EUROŠPED) |
| 2. Jovana Kostić ([SRB] CRVENA ZVEZDA) |
| 3. Stefani Zdravković ([SRB] EUROŠPED) |
| 3. Marika Ranitović ([SRB] OMEGA-BEOGRAD) |

15. Millennium Open
Competition Area 6
Kadet B M-33

2 competitors
2024-01-20

478 - Vanja Kolarov
[SRB] VRŠAC

465
(0:2)

619

Medesan Raul Mihai - 465
[ROU] ASOCIATIA ROMANA DE TAEKWONDO

1. Medesan Raul Mihai ([ROU] ASOCIATIA ROMANA...
2. Vanja Kolarov ([SRB] VRŠAC)
3.
3.

15. Millennium Open Competition Area 6 Kadet B M-37

3 competitors
2024-01-20

418 - Vuk Maljević
[SRB] POBEDNIK

Sipos Yannis - 466

[ROU] ASOCIATIA ROMANA DE TAEKWONDO

492 - Denis Urda
[ROU] BLACK TIGER

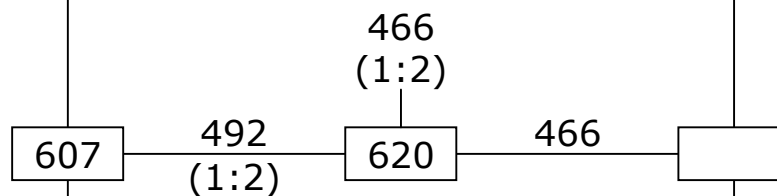

- | |
|---|
| 1. Sipos Yannis ([ROU] ASOCIATIA ROMANA DE TAE... |
| 2. Denis Urda ([ROU] BLACK TIGER) |
| 3. Vuk Maljević ([SRB] POBEDNIK) |
| 3. |

15. Millennium Open Competition Area 7 Kadet B M-41

3 competitors
2024-01-20

422 - Mihailo Vojinović
[SRB] POBEDNIK

Aleksandar Đorić - 525
[SRB] ASTERIKS

461 - Silaghi Zoltan
[ROU] ASOCIATIA ROMANA DE TAEKWONDO

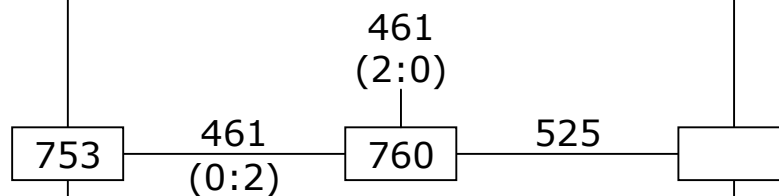

1. Silaghi Zoltan ([ROU] ASOCIATIA ROMANA DE TA...
2. Aleksandar Đorić ([SRB] ASTERIKS)
3. Mihailo Vojinović ([SRB] POBEDNIK)
3.

15. Millennium Open
Competition Area 7
Kadet B M-45

2 competitors
2024-01-20

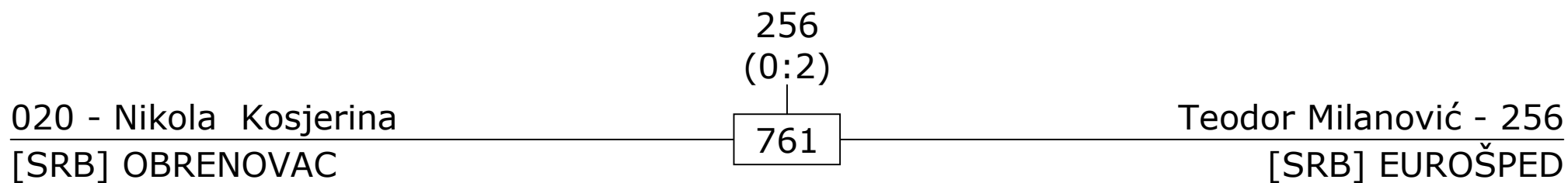

1. Teodor Milanović ([SRB] EUROŠPED)
2. Nikola Kosjerina ([SRB] OBRENOVAC)
3.
3.

15. Millennium Open Competition Area 7 Kadet B M-49

4 competitors
2024-01-20

432 - Levente Sztano
[HUN] TAEKWONDO FANATIX

Vasilije Bjelic - 378
[SRB] VOJVODINA

419 - Andreja Pećanac
[SRB] POBEDNIK

Stefan Trninić - 250
[SRB] ELIT

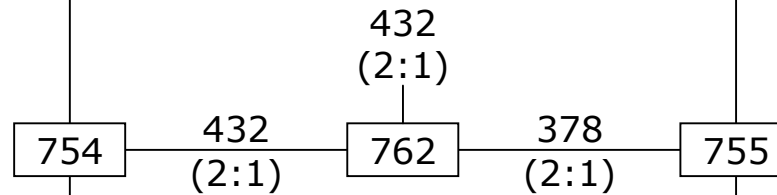

1. Levente Sztano ([HUN] TAEKWONDO FANATIX)

2. Vasilije Bjelic ([SRB] VOJVODINA)

3. Stefan Trninić ([SRB] ELIT)

3. Andreja Pećanac ([SRB] POBEDNIK)

15. Millennium Open Competition Area 6 Kadet B M-57

6 competitors
2024-01-20

047 - Vanja Serdarević
[SRB] GALEB

052 - Iacob Vladimir
[ROU] ASOCIATIA ROMANA DE TAEKWONDO

023 - Dejvid Đorđe
[SRB] EUROŠPED

Vukan Brstina - 049
[SRB] OLIMP

Nicolas Oanca - 242
[ROU] BLACK TIGER

Andrej Tasevski - 138
[SRB] KOLOSEUM

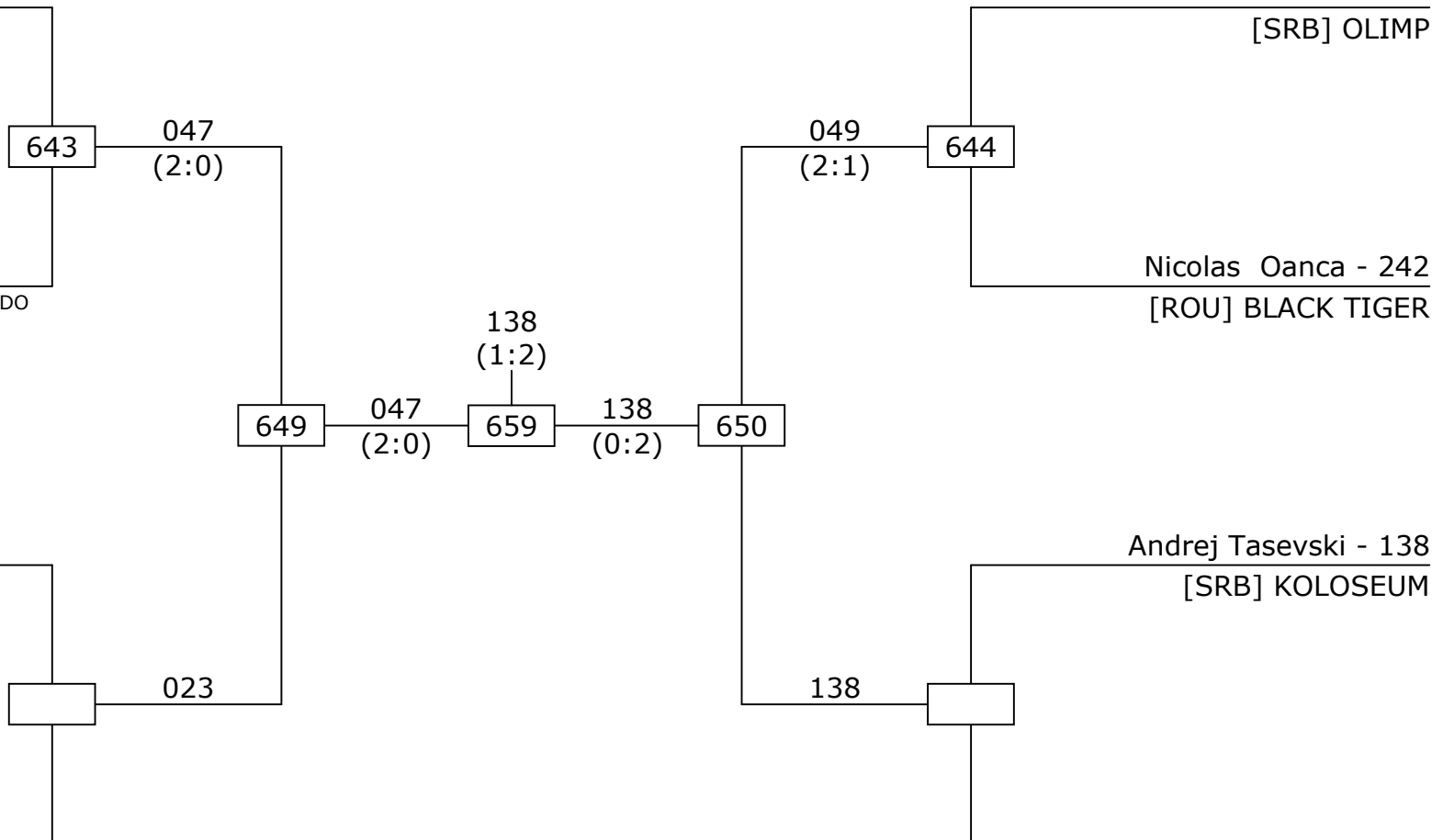

- | |
|-------------------------------------|
| 1. Andrej Tasevski ([SRB] KOLOSEUM) |
| 2. Vanja Serdarević ([SRB] GALEB) |
| 3. Vukan Brstina ([SRB] OLIMP) |
| 3. Dejvid Đorđe ([SRB] EUROŠPED) |

15. Millennium Open
Competition Area 6
Kadet B M-61

2 competitors
2024-01-20

155 - Petar Galović
[SRB] GITROS

155
(2:1)
660

Matei Popa - 074
[ROU] BLACK TIGER

1. Petar Galović ([SRB] GITROS)
2. Matei Popa ([ROU] BLACK TIGER)
3.
3.

15. Millennium Open Competition Area 2 Kadet A F-29

3 competitors
2024-01-20

297 - Elena Mihaljčić
[SRB] HERKULES

Paula Costea - 515
[ROU] BLACK TIGER

484 - Nedzla Musić
[BIH] LJUBIJA-PRIJEDOR

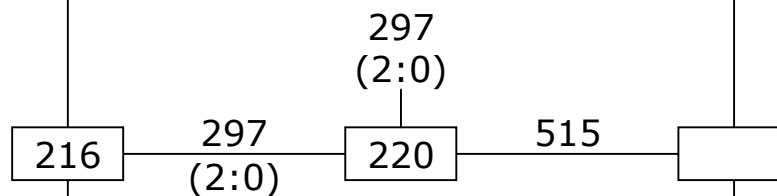

1. Elena Mihaljčić ([SRB] HERKULES)

2. Paula Costea ([ROU] BLACK TIGER)

3. Nedzla Musić ([BIH] LJUBIJA-PRIJEDOR)

3.

15. Millennium Open Competition Area 2 Kadet A F-33

8 competitors
2024-01-20

170 - Dunja Ilijevski
[SRB] LETNJIKOVAC

529 - Masa Caran
[SRB] EUROŠPED

084 - Jana Lazovic
[SRB] KORIO 2

228 - Anastasija Marić
[SRB] AZIJA

Dunja Marković - 161
[SRB] LETNJIKOVAC

Iva Ilić - 321
[SRB] OMEGA-BEOGRAD

Lena Rajković - 291
[SRB] ŠAMPION

Nađa Babić - 304
[SRB] HERKULES

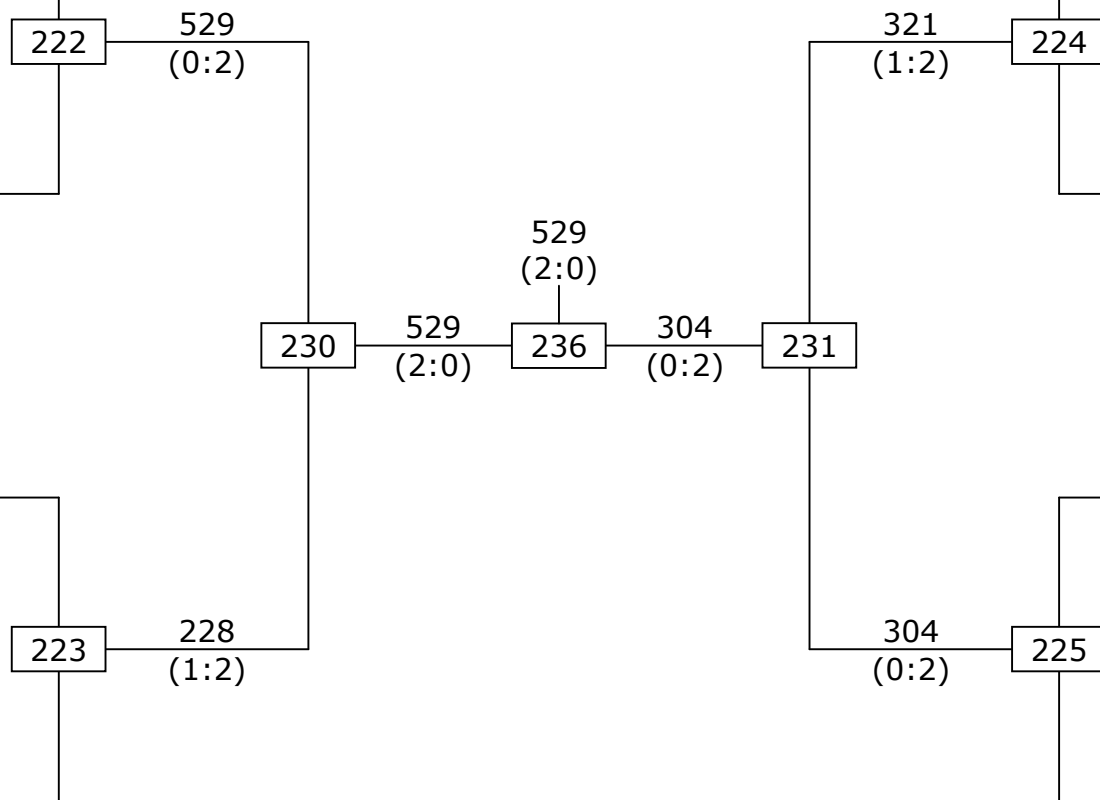

- | |
|-----------------------------------|
| 1. Masa Caran ([SRB] EUROŠPED) |
| 2. Nađa Babić ([SRB] HERKULES) |
| 3. Iva Ilić ([SRB] OMEGA-BEOGRAD) |
| 3. Anastasija Marić ([SRB] AZIJA) |

15. Millennium Open Competition Area 2 Kadet A F-37

11 competitors
2024-01-20



15. Millennium Open Competition Area 3 Kadet A F-41

5 competitors
2024-01-20

192 - Nadja Dragičević

[SRB] SPARTA

Nađa Đinović - 097

[SRB] OLIMP

300 - Katarina Džalev

[SRB] HERKULES

247 - Marija Milivojević

[SRB] ELIT

Mia Buneta - 405

[SRB] ELIT

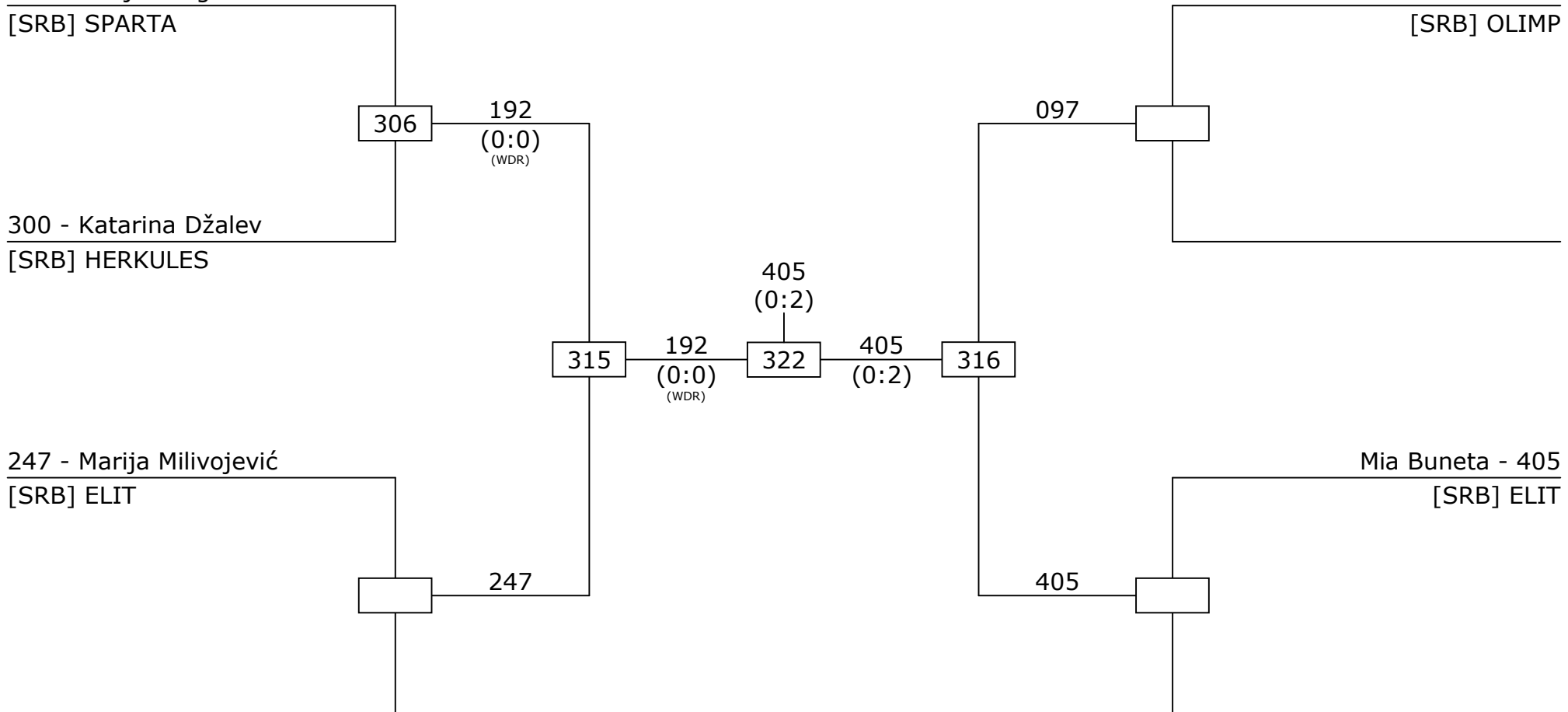

- | |
|------------------------------------|
| 1. Mia Buneta ([SRB] ELIT) |
| 2. Nadja Dragičević ([SRB] SPARTA) |
| 3. Nađa Đinović ([SRB] OLIMP) |
| 3. Marija Milivojević ([SRB] ELIT) |

15. Millennium Open Competition Area 3 Kadet A F-44

9 competitors
2024-01-20

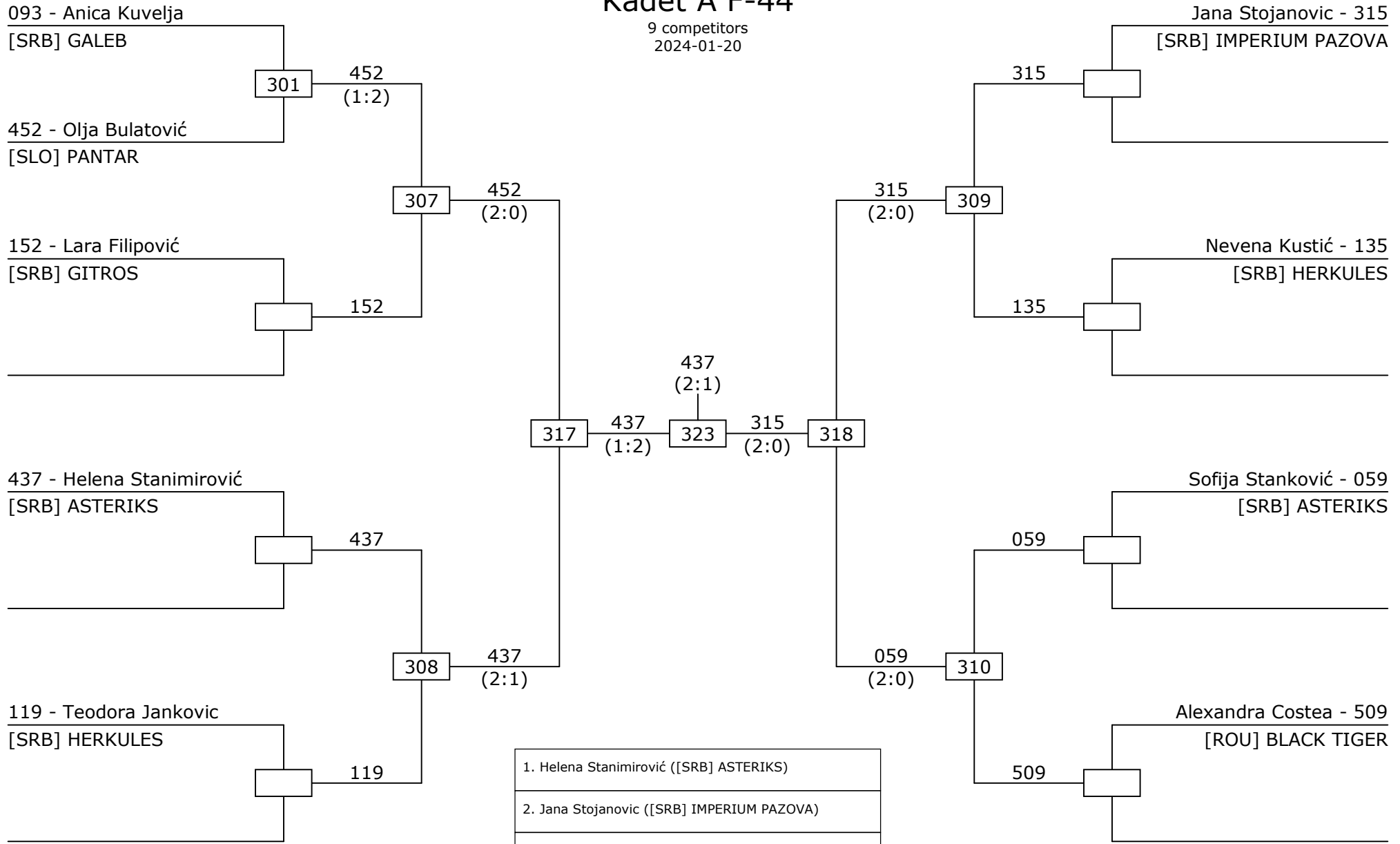

15. Millennium Open Competition Area 3 Kadet A F-47

12 competitors
2024-01-20



15. Millennium Open Competition Area 4 Kadet A F-55

11 competitors
2024-01-20

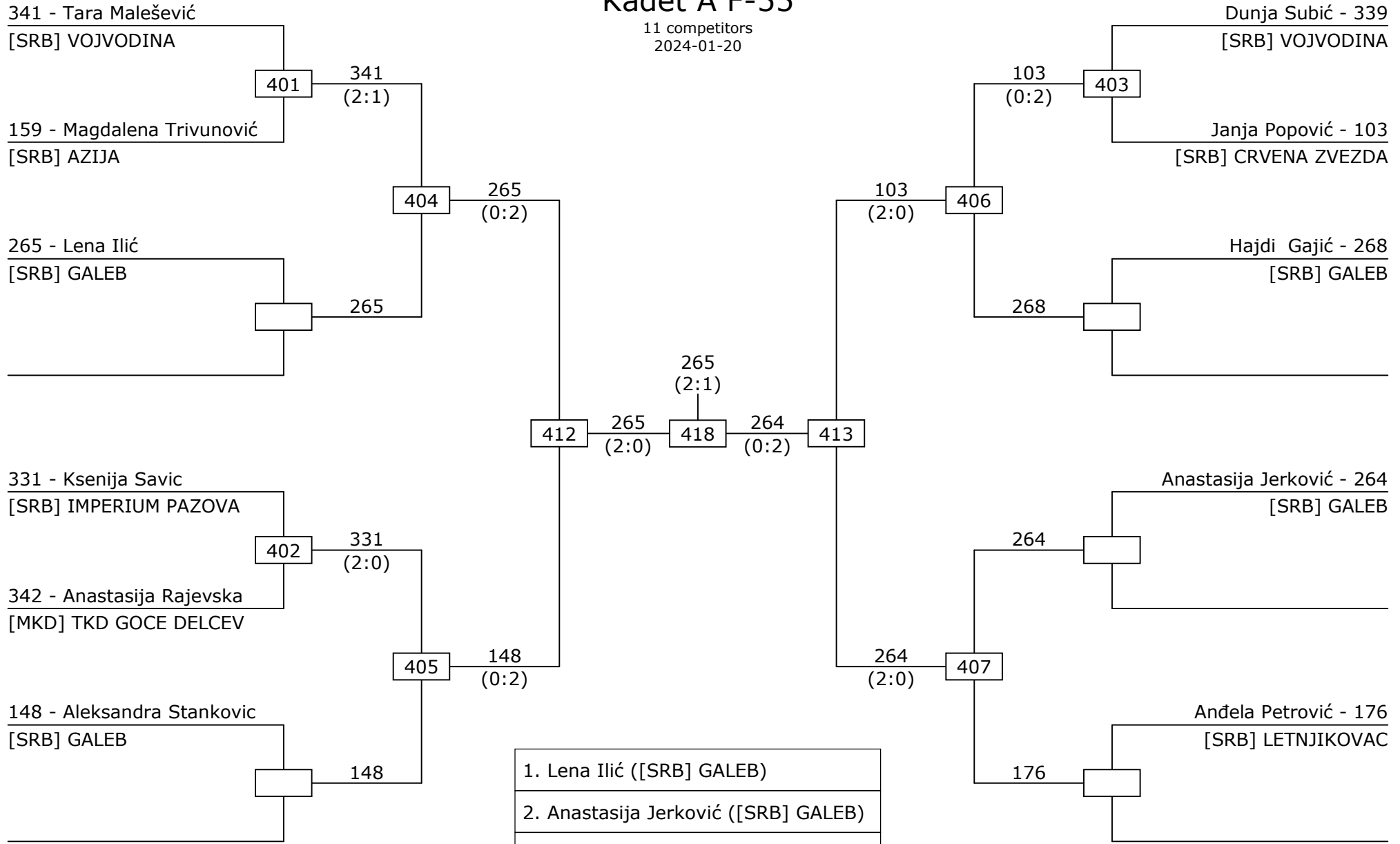

15. Millennium Open Competition Area 4 Kadet A F-59

6 competitors
2024-01-20

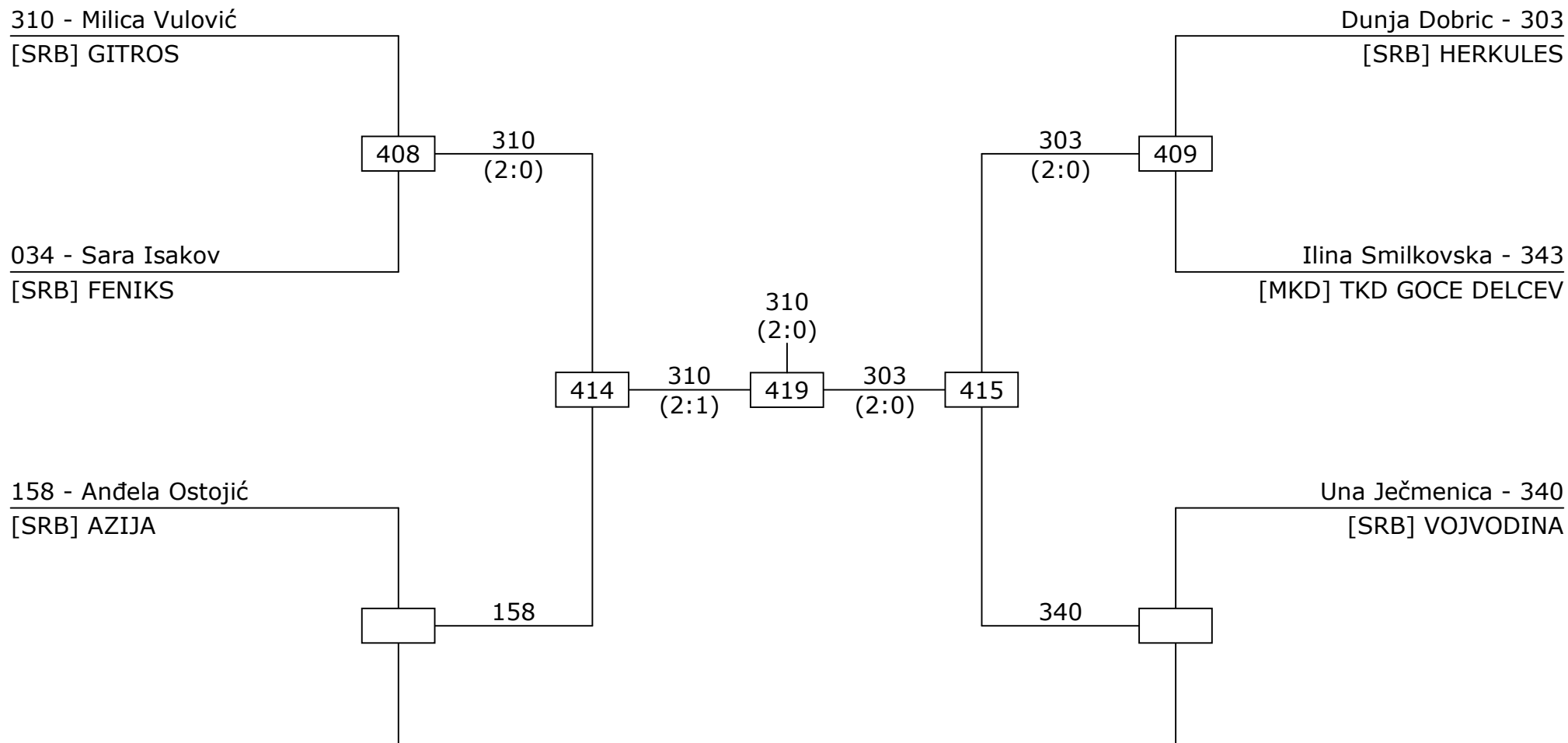

- | |
|------------------------------------|
| 1. Milica Vulović ([SRB] GITROS) |
| 2. Dunja Dobric ([SRB] HERKULES) |
| 3. Una Ječmenica ([SRB] VOJVODINA) |
| 3. Anđela Ostojić ([SRB] AZIJA) |

15. Millennium Open Competition Area 4 Kadet A F+59

6 competitors
2024-01-20

354 - Nina Narandzic
[SRB] EUROŠPED

083 - Jana Savic
[SRB] KORIO 2

105 - Aleksandra Popović
[SRB] CRVENA ZVEZDA

Sofija Radovanović - 101
[SRB] CRVENA ZVEZDA

Marija Vujičić - 115
[SRB] TORNADO

Elena Ilić - 195
[SRB] SPARTA

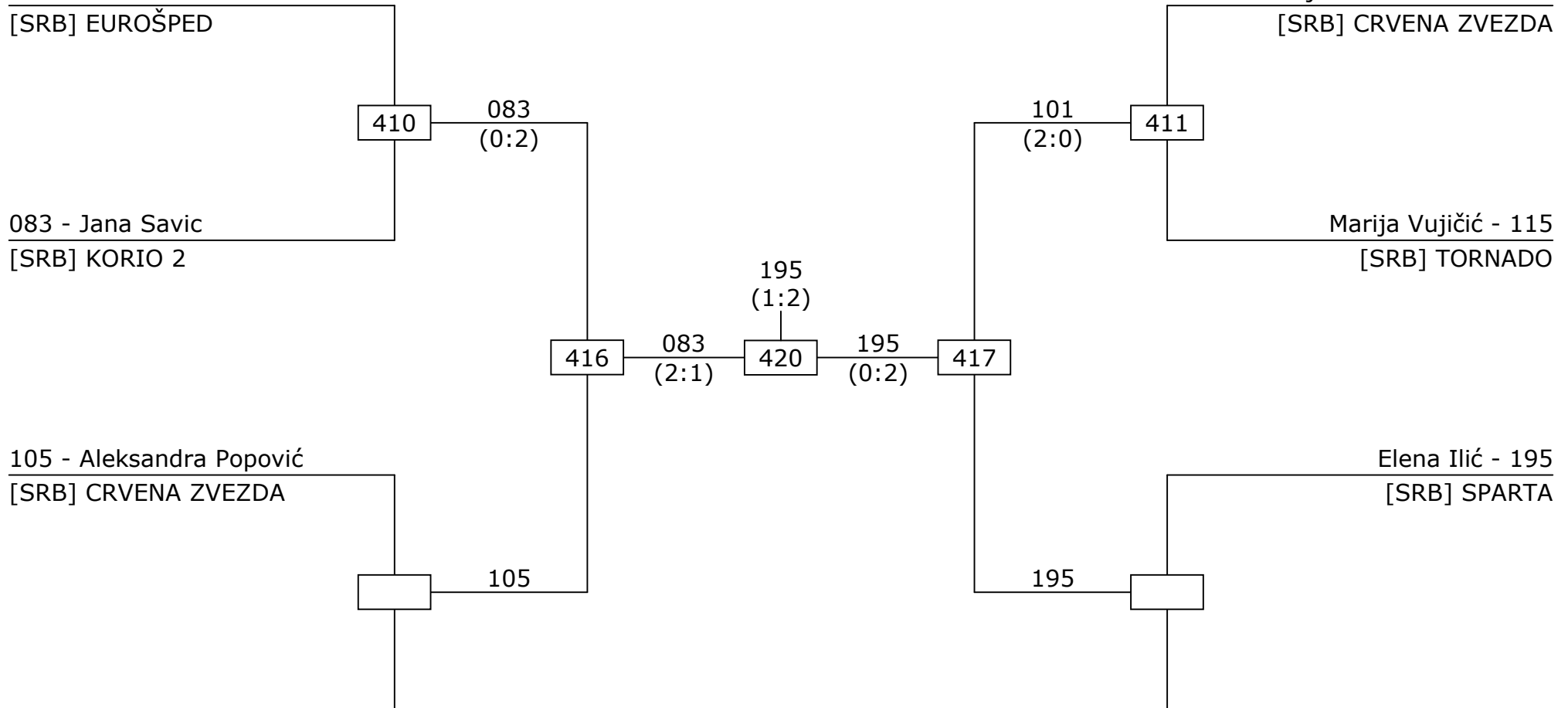

- | |
|---|
| 1. Elena Ilić ([SRB] SPARTA) |
| 2. Jana Savic ([SRB] KORIO 2) |
| 3. Sofija Radovanović ([SRB] CRVENA ZVEZDA) |
| 3. Aleksandra Popović ([SRB] CRVENA ZVEZDA) |

15. Millennium Open Competition Area 2 Kadet A M-33

8 competitors
2024-01-20

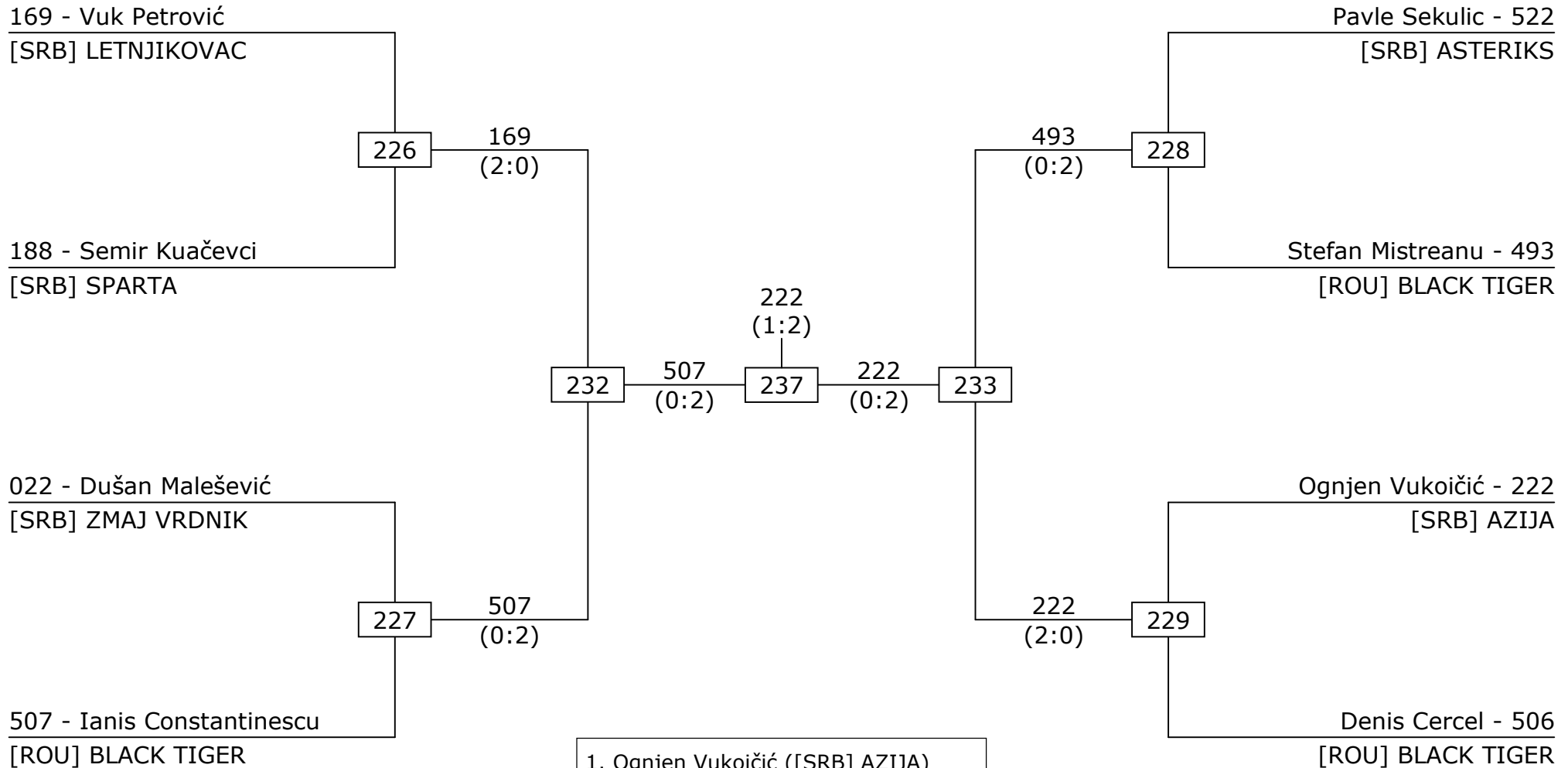

- | |
|---|
| 1. Ognjen Vukoičić ([SRB] AZIJA) |
| 2. Ianis Constantinescu ([ROU] BLACK TIGER) |
| 3. Stefan Mistreanu ([ROU] BLACK TIGER) |
| 3. Vuk Petrović ([SRB] LETNJIKOVAC) |

15. Millennium Open Competition Area 2 Kadet A M-37

4 competitors
2024-01-20

217 - Vuk Nevenkić
[SRB] AZIJA

Dimitrije Andjelković - 035
[SRB] FENIKS

499 - Vlad-Felix Mihaila
[ROU] BLACK TIGER

Cristian Melescanu - 067
[ROU] BLACK TIGER

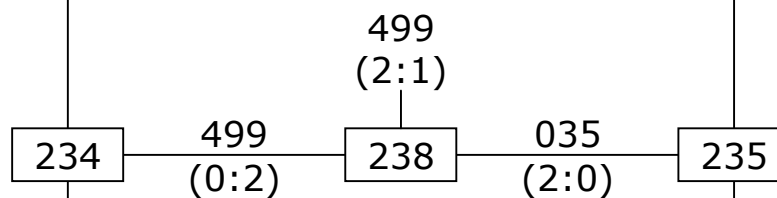

1. Vlad-Felix Mihaila ([ROU] BLACK TIGER)

2. Dimitrije Andjelković ([SRB] FENIKS)

3. Cristian Melescanu ([ROU] BLACK TIGER)

3. Vuk Nevenkić ([SRB] AZIJA)

15. Millennium Open Competition Area 2 Kadet A M-41

6 competitors
2024-01-20

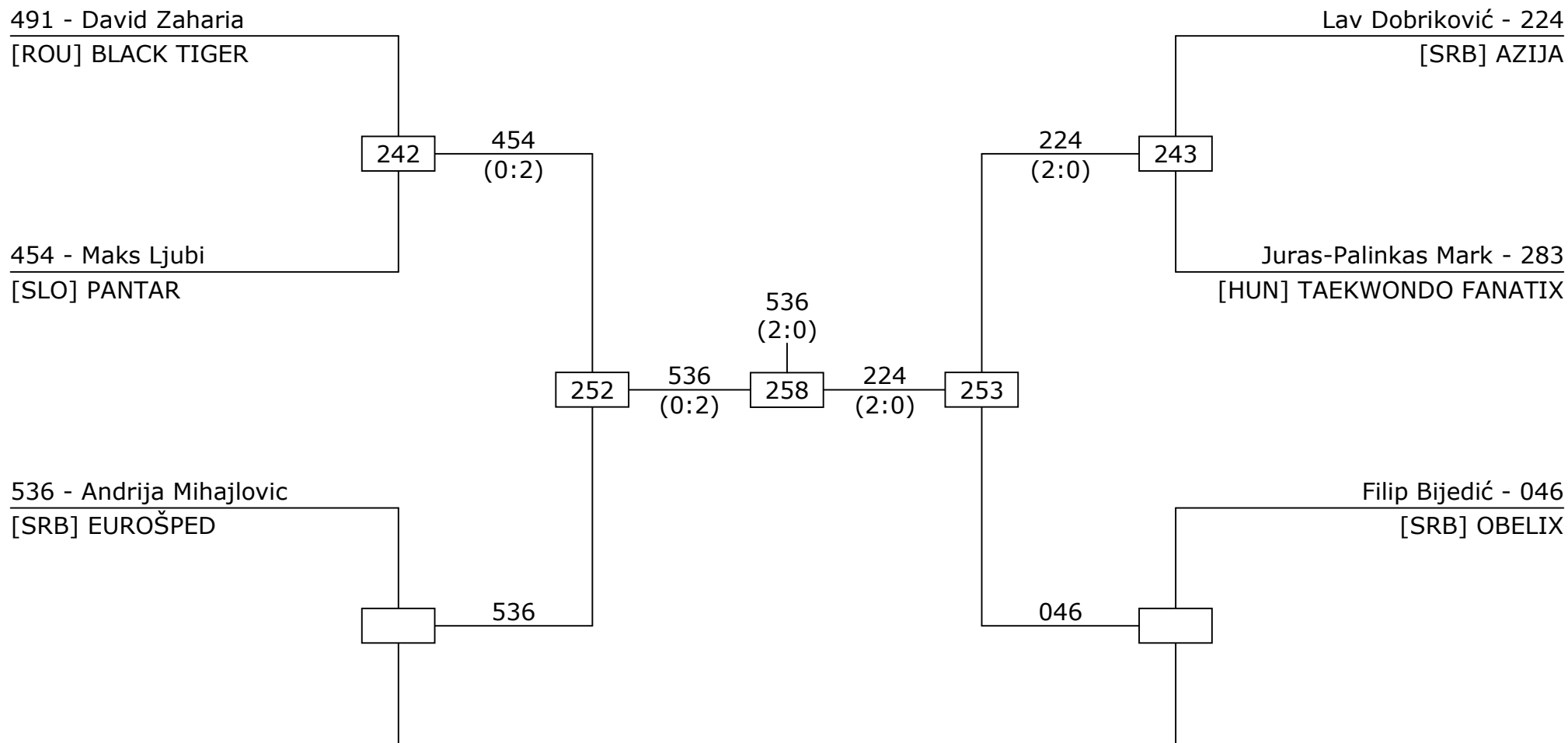

- | |
|--|
| 1. Andrija Mihajlovic ([SRB] EUROŠPED) |
| 2. Lav Dobriković ([SRB] AZIJA) |
| 3. Filip Bijedić ([SRB] OBELIX) |
| 3. Maks Ljubi ([SLO] PANTAR) |

15. Millennium Open Competition Area 2 Kadet A M-49

9 competitors
2024-01-20

472 - Cîmpean Ovidiu Cristian
[ROU] ASOCIATIA ROMANA DE TAEKWON...

518 - Mijat Stupljanin
[SRB] ASTERIKS

099 - Marko Ferenci
[SRB] OLIMP

271 - Aleksandar Savković
[SRB] GALEB

038 - Matija Pavlović
[SRB] FENIKS

Mihajlo Kozma - 387
[SRB] GALEB

Jovan Tomic - 359
[SRB] EUROŠPED

Novak Jovičić - 146
[SRB] PEGASUS

David Hegedis - 123
[SRB] STIL

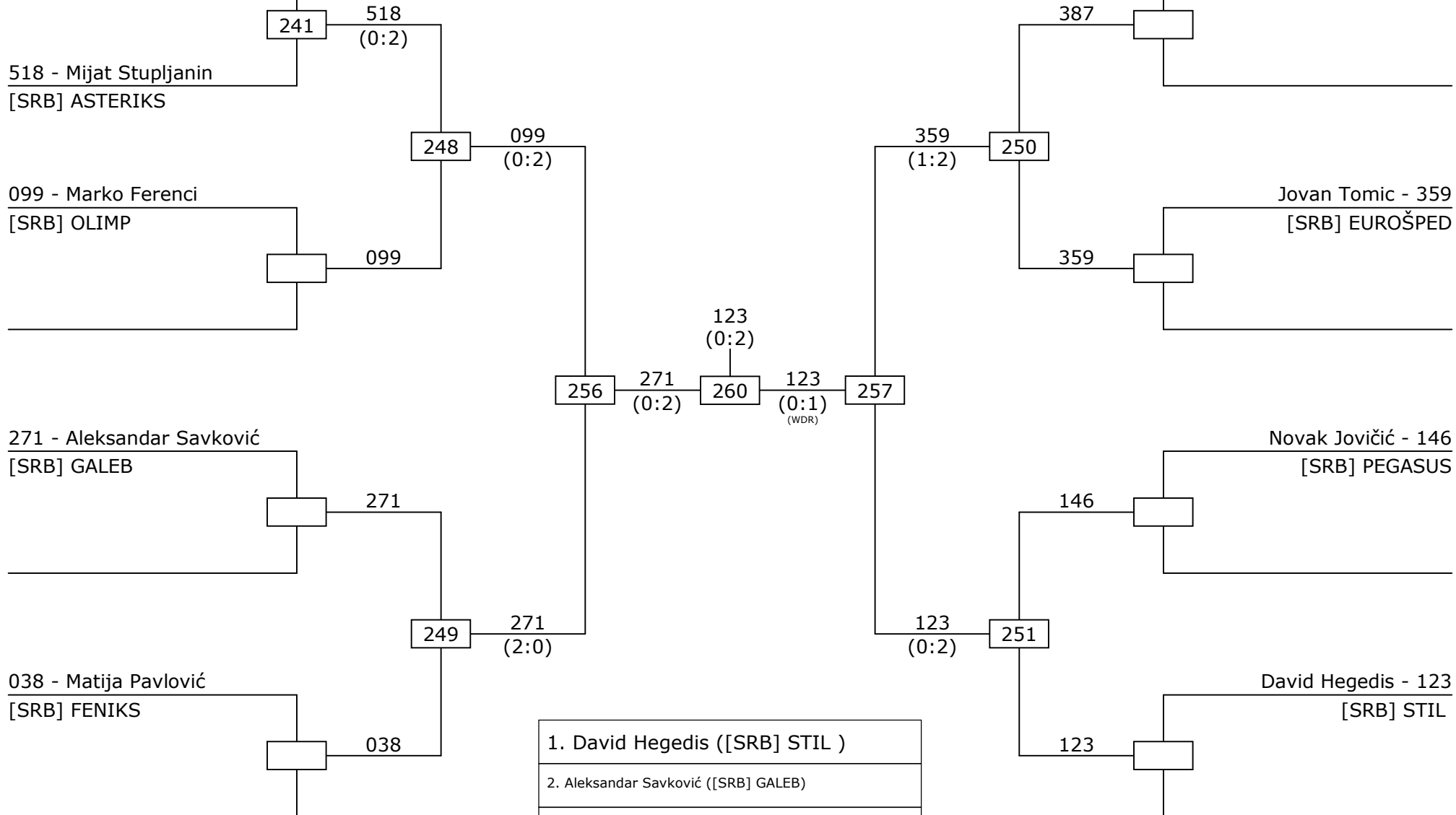

- | |
|--------------------------------------|
| 1. David Hegedis ([SRB] STIL) |
| 2. Aleksandar Savković ([SRB] GALEB) |
| 3. Jovan Tomic ([SRB] EUROŠPED) |
| 3. Marko Ferenci ([SRB] OLIMP) |

15. Millennium Open
Competition Area 4
Kadet A M-53

2 competitors
2024-01-20

284 - Aleksa Marković
[SRB] GALEB

007
(1:2)

431

Gorgia Angelevski - 007
[MKD] TKD KORIO - KISELA VODA

1. Gorgia Angelevski ([MKD] TKD KORIO - KISELA V...
2. Aleksa Marković ([SRB] GALEB)
3.
3.

15. Millennium Open Competition Area 4 Kadet A M-57

6 competitors
2024-01-20

200 - Ažbe Tešar
[SLO] PANTAR

404 - Lazar Jankovic
[SRB] ELIT

122 - David Ilić
[SRB] GALEB

Uros Stanojevic - 309
[SRB] OMEGA-BEOGRAD

Marosi Milan - 430
[HUN] TAEKWONDO FANATIX

Viktor Dobrić - 306
[SRB] PEGASUS

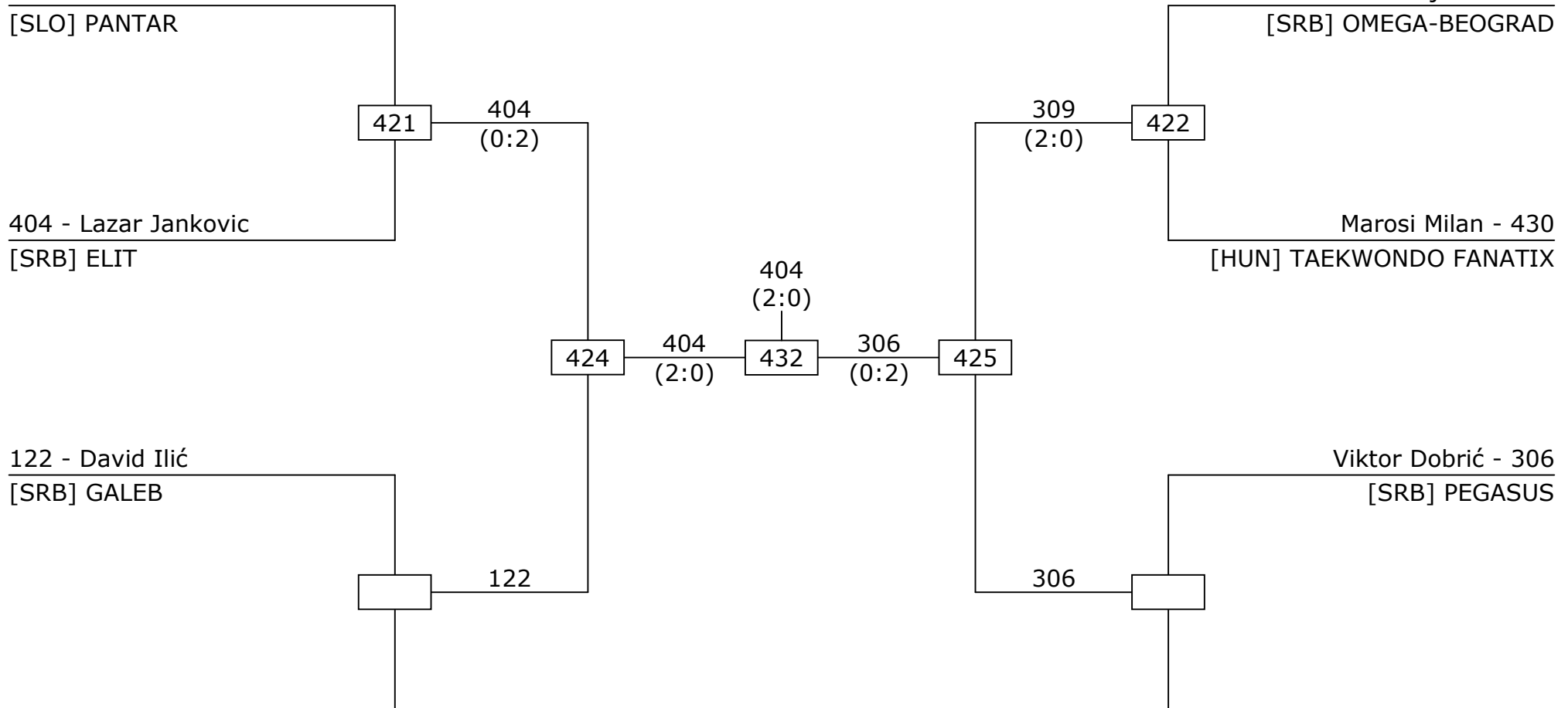

- | |
|--|
| 1. Lazar Jankovic ([SRB] ELIT) |
| 2. Viktor Dobrić ([SRB] PEGASUS) |
| 3. Uros Stanojevic ([SRB] OMEGA-BEOGRAD) |
| 3. David Ilić ([SRB] GALEB) |

15. Millennium Open Competition Area 4 Kadet A M-65

3 competitors
2024-01-20

323 - Mateja Martac
[SRB] OMEGA-BEOGRAD

Stefan Grujičić - 004
[SRB] AZIJA

467 - Damalan Vlad Andrei
[ROU] ASOCIATIA ROMANA DE TAEKWONDO

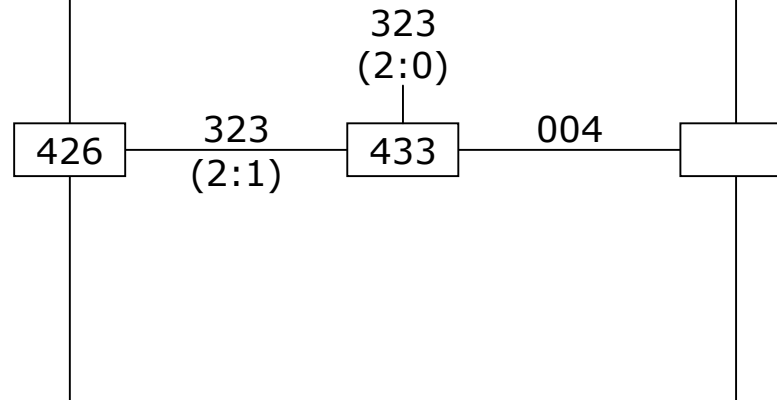

1. Mateja Martac ([SRB] OMEGA-BEOGRAD)
2. Stefan Grujičić ([SRB] AZIJA)
3. Damalan Vlad Andrei ([ROU] ASOCIATIA ROMANA...)
3.

15. Millennium Open Competition Area 4 Kadet A M+65

4 competitors
2024-01-20

371 - Pavel Jovanovski

[MKD] TKD KORIO - KISELA VODA

Filip Čolović - 024

[SRB] POBEDNIK

425 - Vuk Babić

[SRB] POBEDNIK

Stefan Brkić - 249

[SRB] ELIT

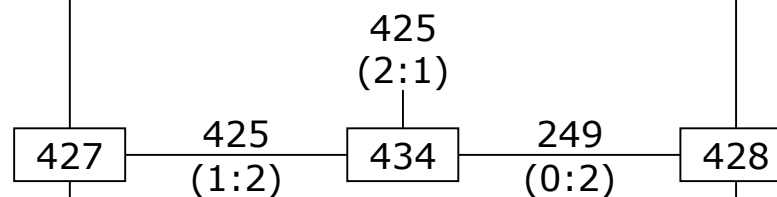

1. Vuk Babić ([SRB] POBEDNIK)

2. Stefan Brkić ([SRB] ELIT)

3. Filip Čolović ([SRB] POBEDNIK)

3. Pavel Jovanovski ([MKD] TKD KORIO - KISELA V...

15. Millennium Open
Competition Area 6
Junior B F-52

2 competitors
2024-01-20

537 - Andrea Miljusevic [SRB] EUROŠPED	537 (2:0) 661	Girlonta Diana - 285 [ROU] ASOCIATIA ROMANA DE TAEKWONDO
---	---------------------	---

1. Andrea Miljusevic ([SRB] EUROŠPED)
2. Girlonta Diana ([ROU] ASOCIATIA ROMANA DE TA...
3.
3.

15. Millennium Open
Competition Area 6
Junior B F-55

2 competitors
2024-01-20

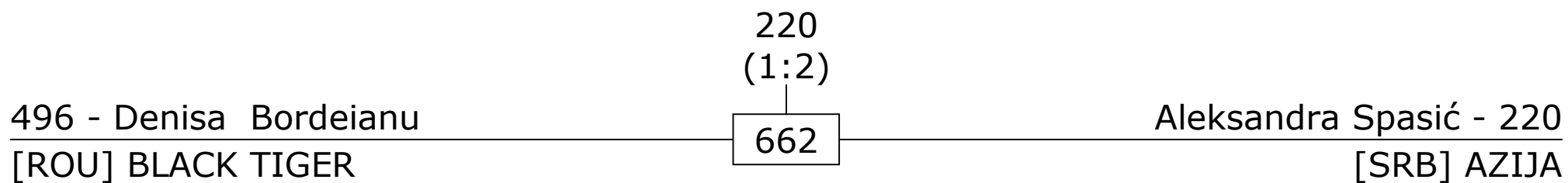

1. Aleksandra Spasić ([SRB] AZIJA)
2. Denisa Bordeianu ([ROU] BLACK TIGER)
3.
3.

15. Millennium Open Competition Area 6 Junior B F-59

3 competitors
2024-01-20

395 - Anastasija Udovčić
[SRB] ZRENJANIN

Lana Obradovic - 296
[SRB] OMEGA-BEOGRAD

014 - Valerija Nikolić
[SRB] OBRENOVAC

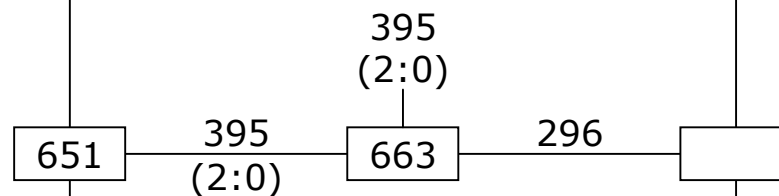

1. Anastasija Udovčić ([SRB] ZRENJANIN)
2. Lana Obradovic ([SRB] OMEGA-BEOGRAD)
3. Valerija Nikolić ([SRB] OBRENOVAC)
3.

15. Millennium Open Competition Area 6 Junior B F+68

3 competitors
2024-01-20

214 - Marija Mrkšić
[SRB] KWON BATAJNICA

Cristiana Cornea - 245
[ROU] BLACK TIGER

243 - Riana Gales
[ROU] BLACK TIGER

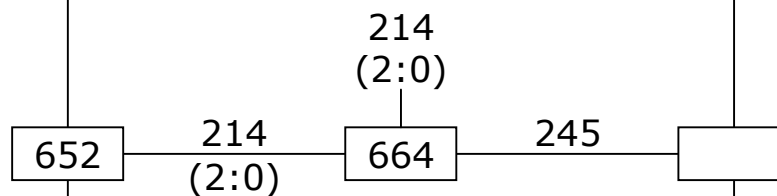

1. Marija Mrkšić ([SRB] KWON BATAJNICA)

2. Cristiana Cornea ([ROU] BLACK TIGER)

3. Riana Gales ([ROU] BLACK TIGER)

3.

15. Millennium Open Competition Area 6 Junior B M-59

4 competitors
2024-01-20

475 - Takacs David

[ROU] ASOCIATIA ROMANA DE TAEKWONDO

Raul Chelariu - 072

[ROU] BLACK TIGER

259 - Vuk Miljojković

[SRB] EUROŠPED

Milan Cvetkovic - 481

[SRB] VRŠAC

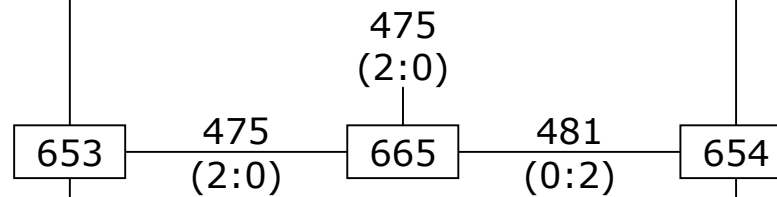

1. Takacs David ([ROU] ASOCIATIA ROMANA DE TA...

2. Milan Cvetkovic ([SRB] VRŠAC)

3. Raul Chelariu ([ROU] BLACK TIGER)

3. Vuk Miljojković ([SRB] EUROŠPED)

15. Millennium Open Competition Area 6 Junior B M-63

3 competitors
2024-01-20

504 - Albert Pralea
[ROU] BLACK TIGER

Bogdan Soloviev - 498
[ROU] BLACK TIGER

311 - Mihajlo Galović
[SRB] GITROS

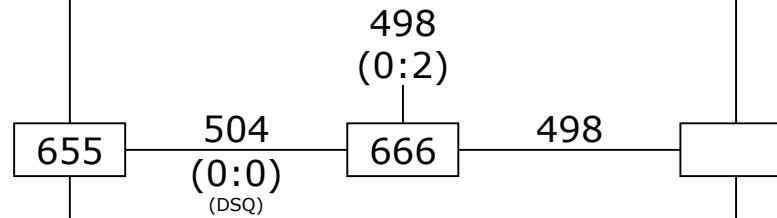

1. Bogdan Soloviev ([ROU] BLACK TIGER)
2. Albert Pralea ([ROU] BLACK TIGER)
3. Mihajlo Galović ([SRB] GITROS)
3.

15. Millennium Open
Competition Area 3
Junior A F-44

2 competitors
2024-01-20

266 - Katarina Petrovic [SRB] GALEB	266 (2:0) 358	Vigh Ingrid - 151 [ROU] ASOCIATIA ROMANA DE TAEKWONDO
--	---------------------	--

1. Katarina Petrovic ([SRB] GALEB)
2. Vigh Ingrid ([ROU] ASOCIATIA ROMANA DE TAEK...
3.
3.

15. Millennium Open Competition Area 3 Junior A F-46

5 competitors
2024-01-20

293 - Ivana Pavlović
[SRB] ŠAMPION

346 - Lana Nestorov
[SRB] EUROŠPED

116 - Andrea Lantoš
[SRB] TORNADO

Đurđa Petrović - 512
[SRB] TEKVONDO AKADEMIJA

Jana Vladov - 015
[SRB] STIL

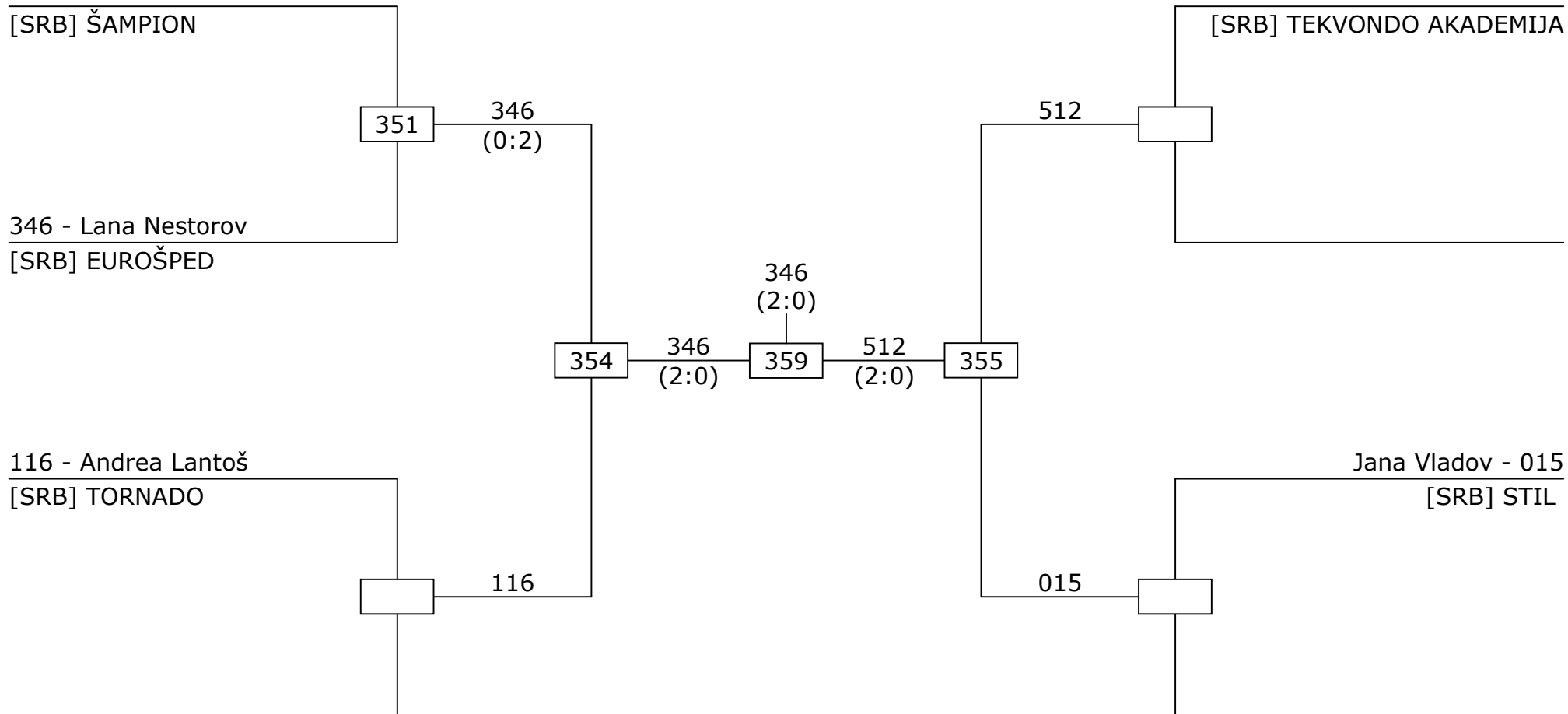

- | |
|--|
| 1. Lana Nestorov ([SRB] EUROŠPED) |
| 2. Đurđa Petrović ([SRB] TEKVONDO AKADEMIJA) |
| 3. Jana Vladov ([SRB] STIL) |
| 3. Andrea Lantoš ([SRB] TORNADO) |

15. Millennium Open Competition Area 3 Junior A F-49

6 competitors
2024-01-20

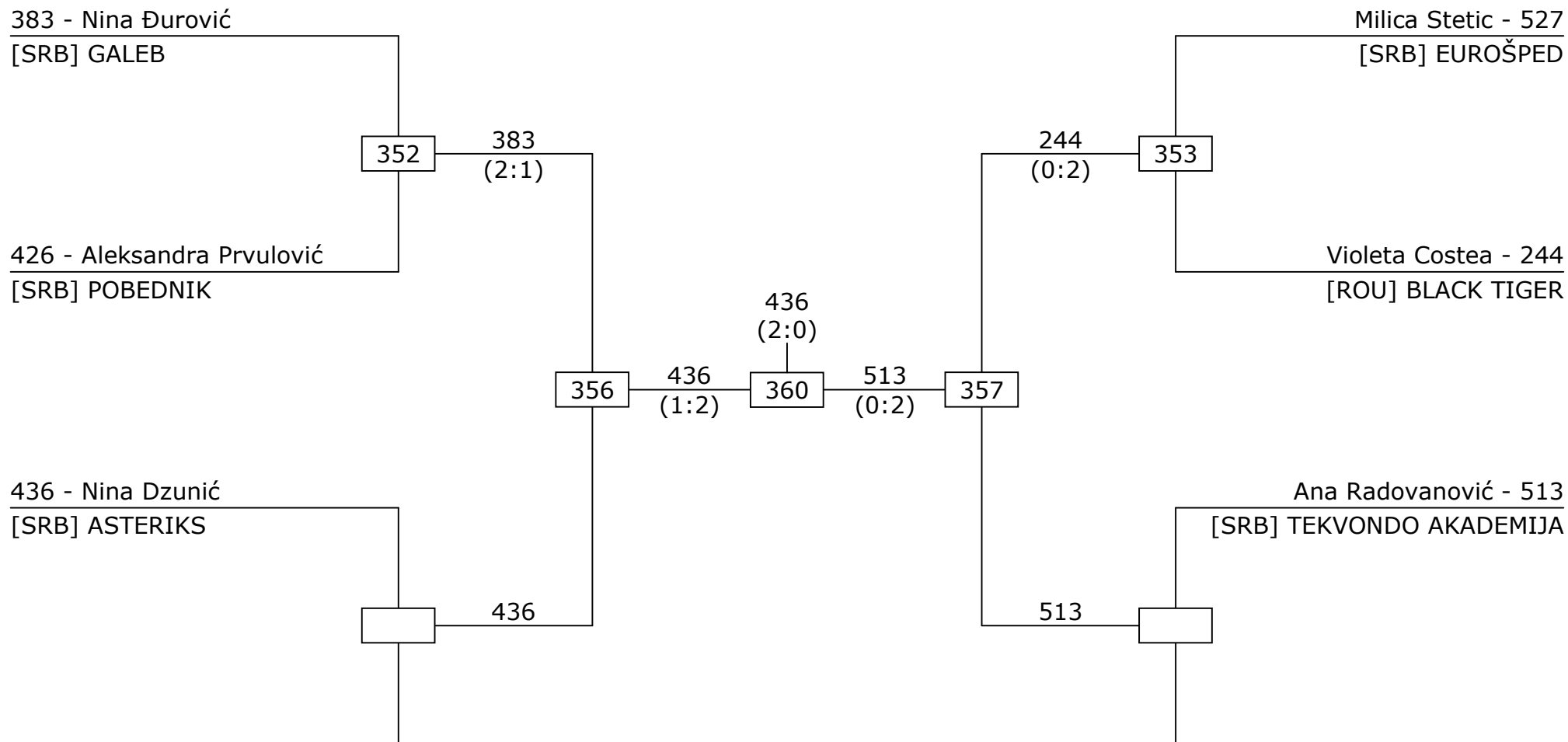

- | |
|---|
| 1. Nina Dzunić ([SRB] ASTERIKS) |
| 2. Ana Radovanović ([SRB] TEKVONDO AKADEMIJA) |
| 3. Violeta Costea ([ROU] BLACK TIGER) |
| 3. Nina Đurović ([SRB] GALEB) |

15. Millennium Open Competition Area 4 Junior A F-52

6 competitors
2024-01-20

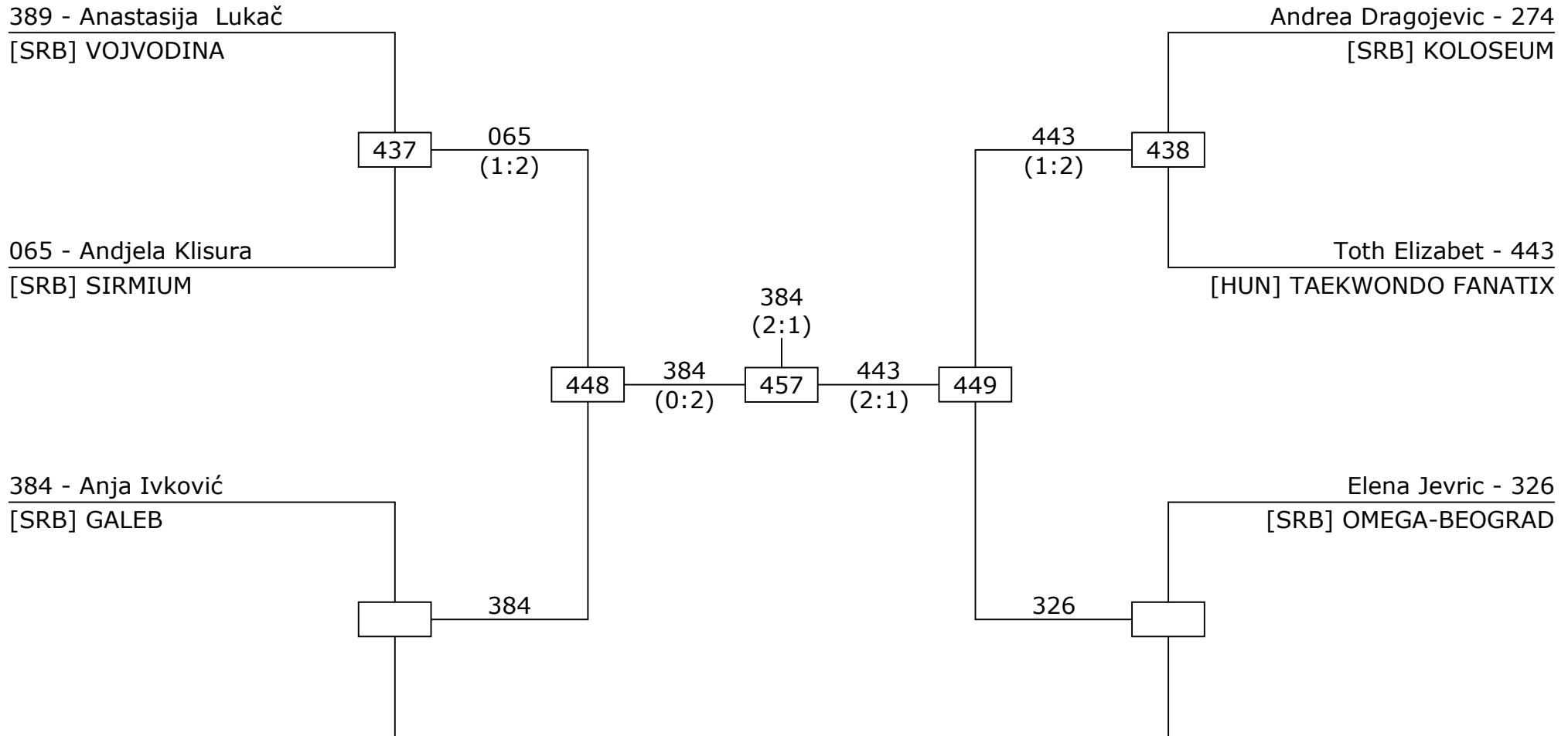

- | |
|--|
| 1. Anja Ivković ([SRB] GALEB) |
| 2. Toth Elizabet ([HUN] TAEKWONDO FANATIX) |
| 3. Elena Jevric ([SRB] OMEGA-BEOGRAD) |
| 3. Andjela Klisura ([SRB] SIRMIUM) |

15. Millennium Open Competition Area 4 Junior A F-55

10 competitors
2024-01-20

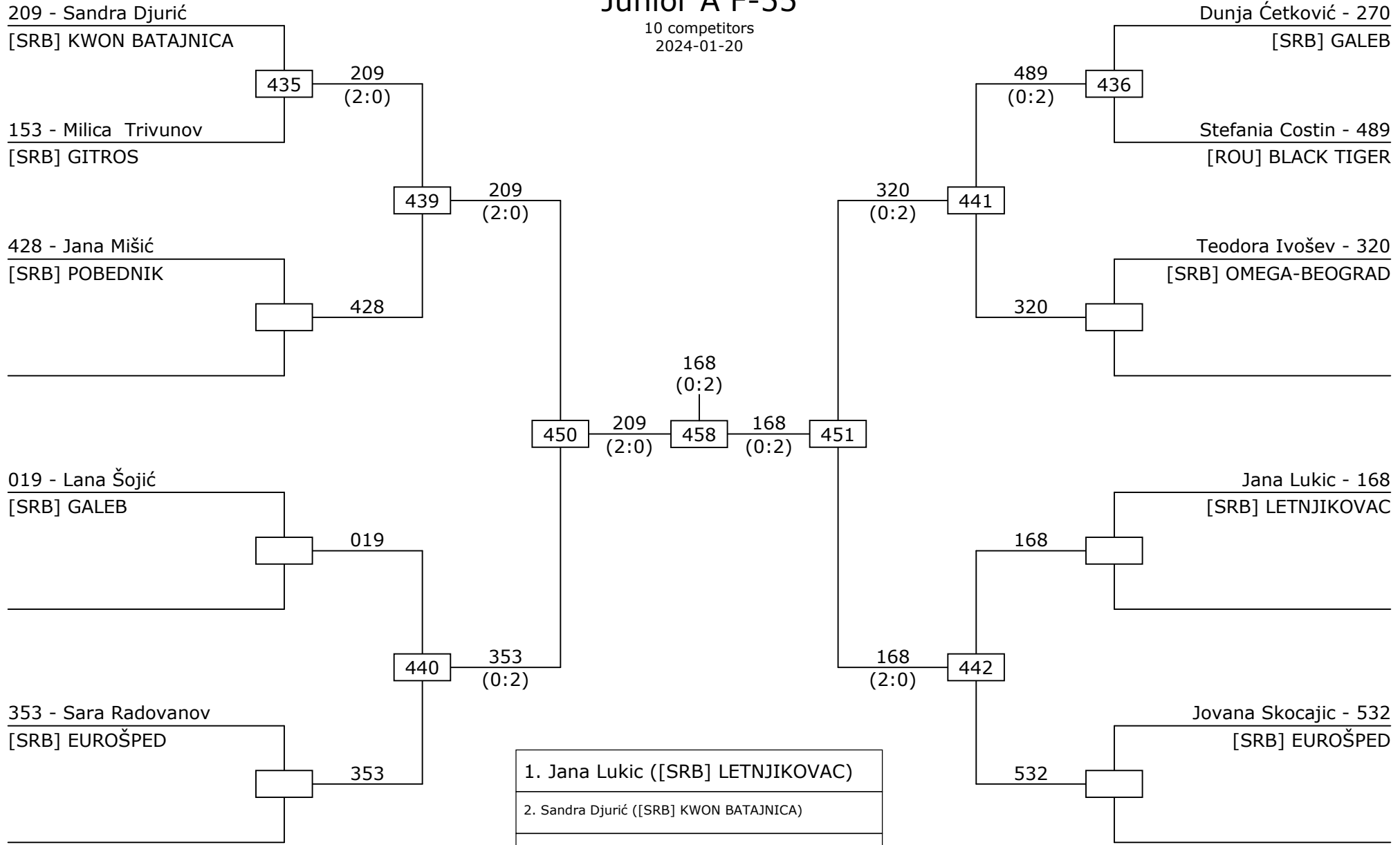

15. Millennium Open Competition Area 4 Junior A F-59

5 competitors
2024-01-20

313 - Sara Stojković
[SRB] GITROS

488 - Teodora Anghel
[ROU] BLACK TIGER

215 - Stasa Knezevic
[SRB] KWON BATAJNICA

Aleksandra Miković - 375
[SRB] GALEB

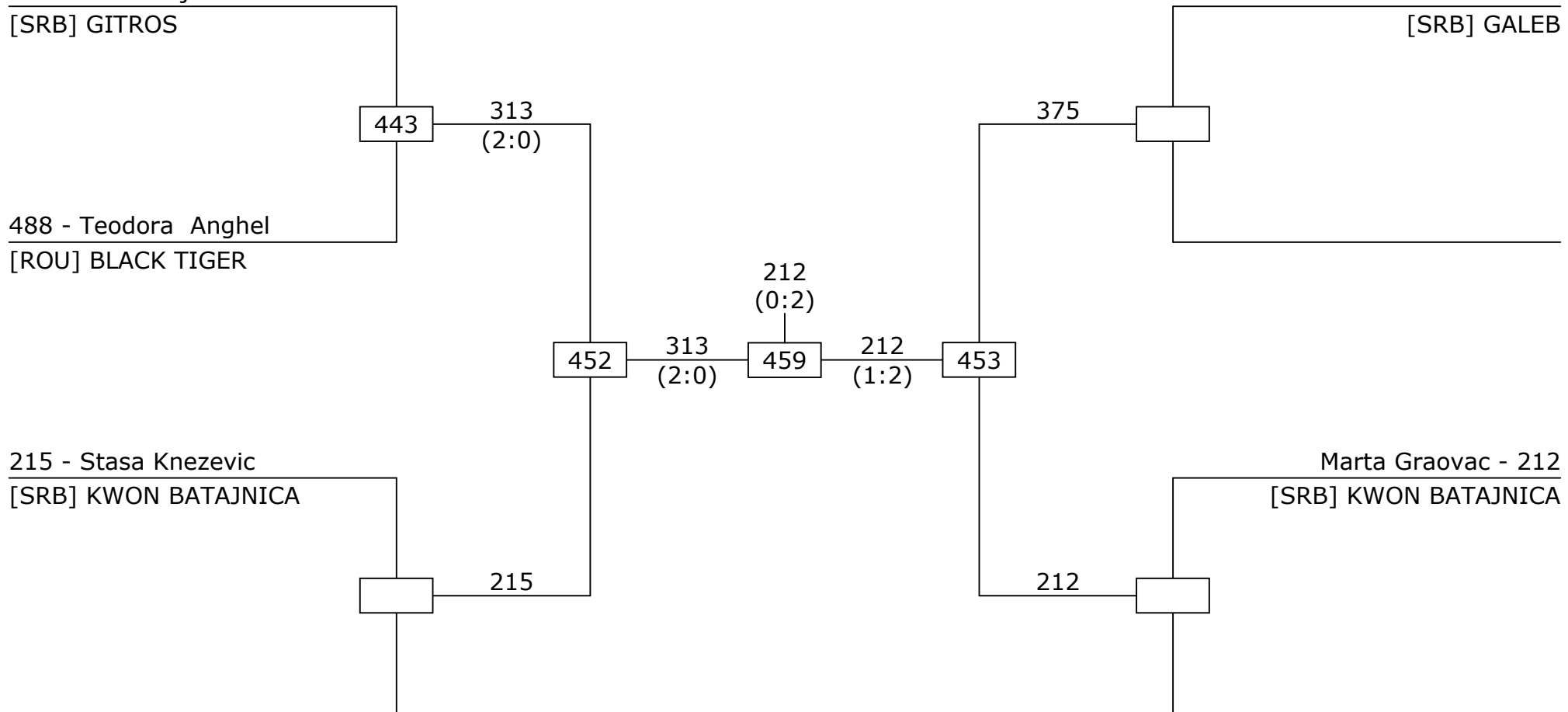

- | |
|--|
| 1. Marta Graovac ([SRB] KWON BATAJNICA) |
| 2. Sara Stojković ([SRB] GITROS) |
| 3. Aleksandra Miković ([SRB] GALEB) |
| 3. Stasa Knezevic ([SRB] KWON BATAJNICA) |

15. Millennium Open Competition Area 5 Junior A F-68

4 competitors
2024-01-20

064 - Anastasija Gadžurić
[SRB] SIRMIUM

Teodora Ribarov - 352
[SRB] EUROŠPED

026 - Milica Ljubinkovic
[SRB] KOBRA

Anusca Cristiana - 150
[ROU] ASOCIATIA ROMANA DE TAEKWONDO

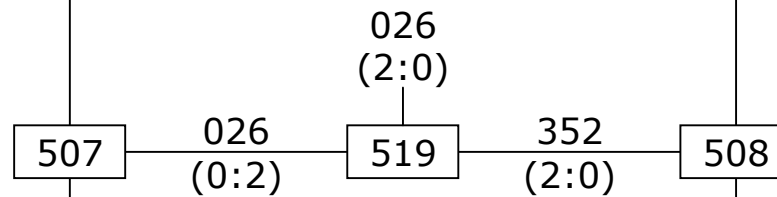

1. Milica Ljubinkovic ([SRB] KOBRA)

2. Teodora Ribarov ([SRB] EUROŠPED)

3. Anusca Cristiana ([ROU] ASOCIATIA ROMANA DE...)

3. Anastasija Gadžurić ([SRB] SIRMIUM)

15. Millennium Open Competition Area 4 Junior A M-55

8 competitors
2024-01-20

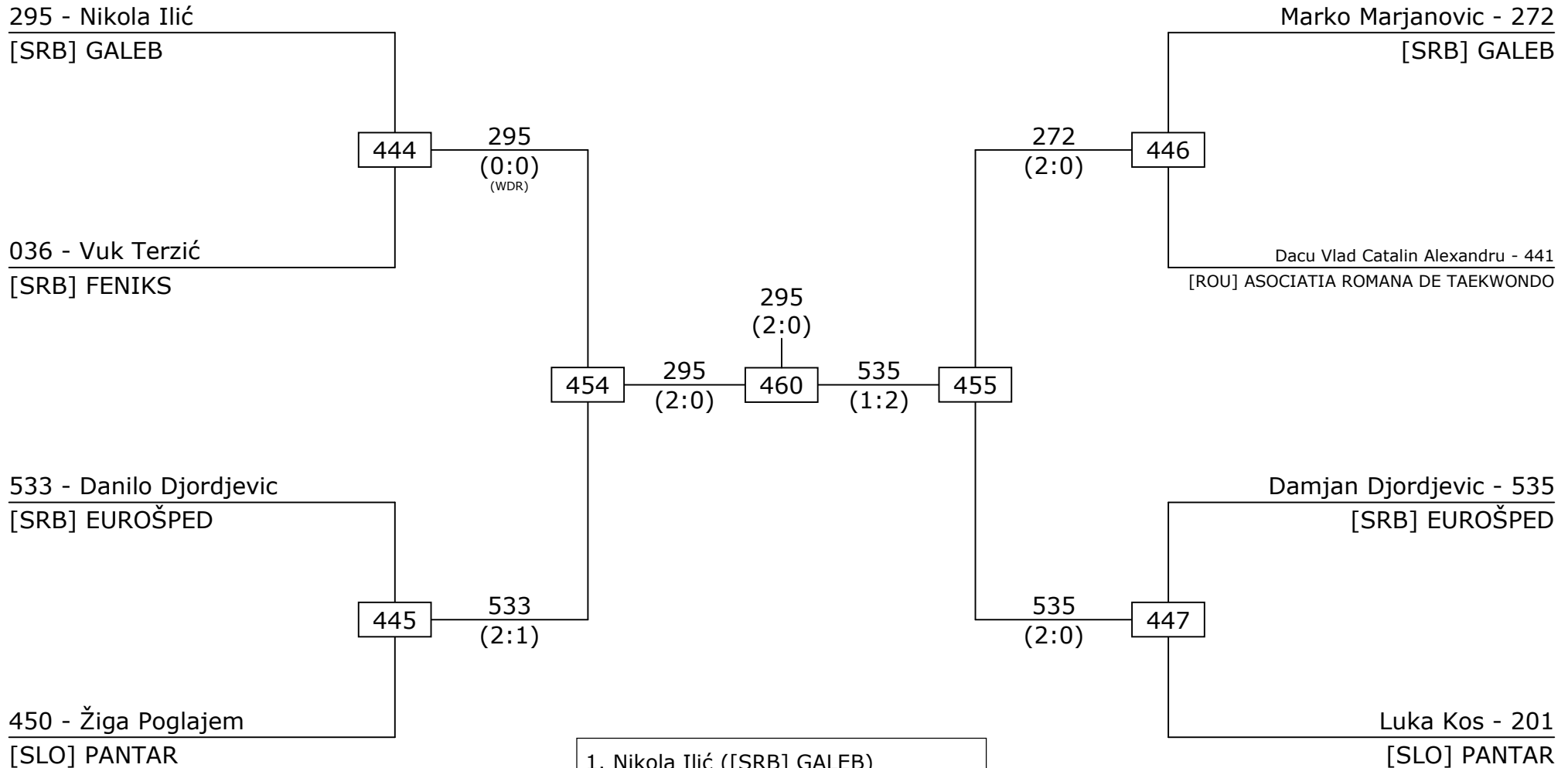

1. Nikola Ilić ([SRB] GALEB)
2. Damjan Djordjevic ([SRB] EUROŠPED)
3. Marko Marjanovic ([SRB] GALEB)
3. Danilo Djordjevic ([SRB] EUROŠPED)

15. Millennium Open Competition Area 5 Junior A M-59

4 competitors
2024-01-20

216 - Mateja Kostić
[SRB] AZIJA

Goran Obradovic - 482
[SRB] VRŠAC

510 - Novak Živanović
[SRB] TEKVONDO AKADEMIJA

Damjan Gorgiovski - 370
[MKD] TKD KORIO - KISELA VODA

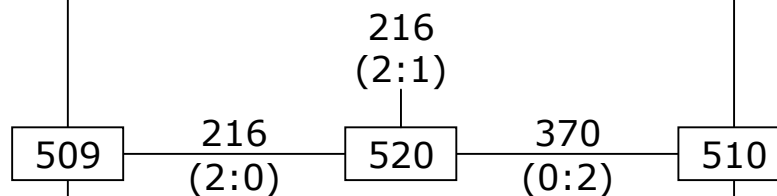

- | |
|---|
| 1. Mateja Kostić ([SRB] AZIJA) |
| 2. Damjan Gorgiovski ([MKD] TKD KORIO - KISELA ...) |
| 3. Goran Obradovic ([SRB] VRŠAC) |
| 3. Novak Živanović ([SRB] TEKVONDO AKADEMIJA) |

15. Millennium Open Competition Area 5 Junior A M-63

7 competitors
2024-01-20

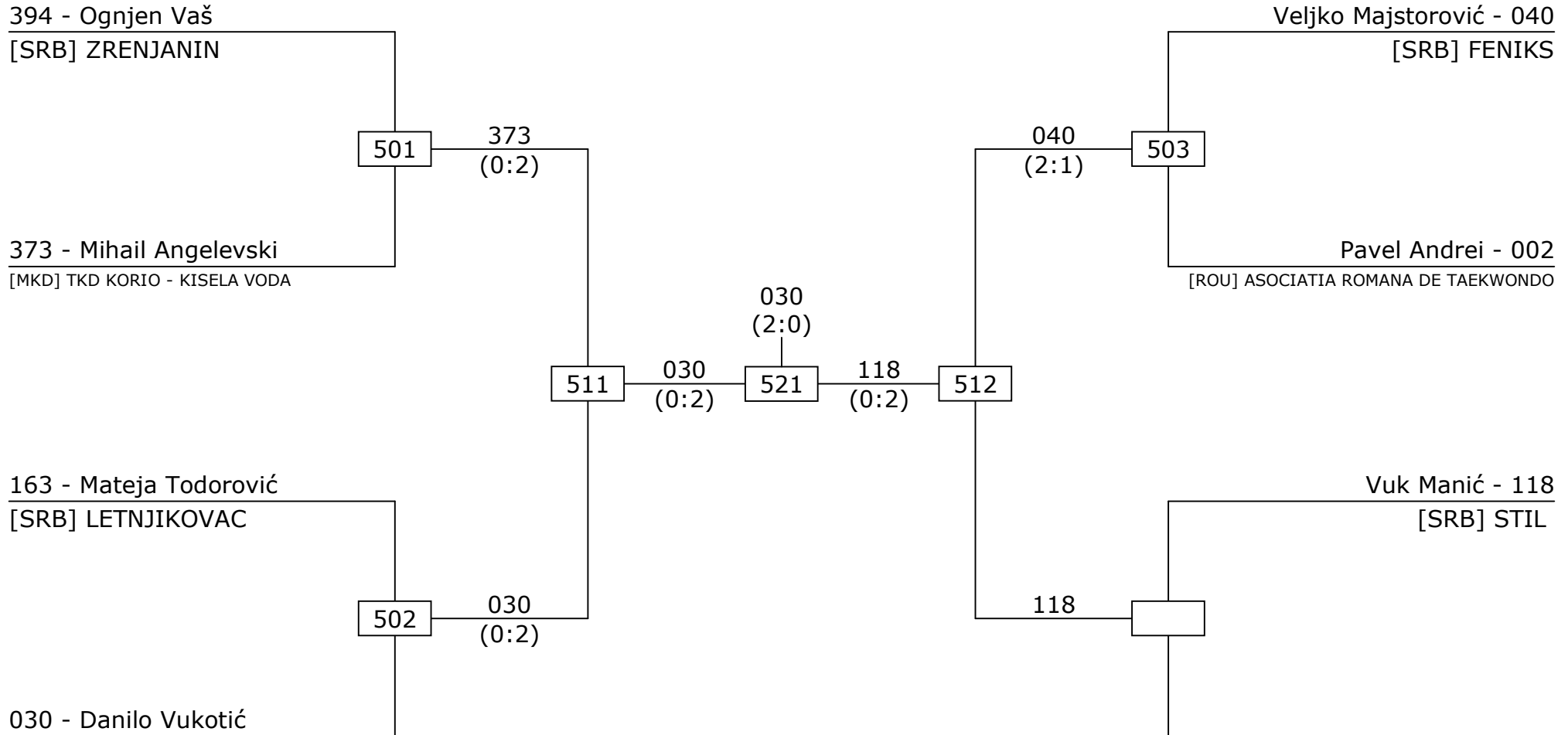

- | |
|---|
| 1. Danilo Vukotić ([BIH] LJUBIJA-PRIJEDOR) |
| 2. Vuk Manić ([SRB] STIL) |
| 3. Veljko Majstorović ([SRB] FENIKS) |
| 3. Mihail Angelevski ([MKD] TKD KORIO - KISELA V... |

15. Millennium Open Competition Area 5 Junior A M-68

4 competitors
2024-01-20

462 - Muntean Dragos

[ROU] ASOCIATIA ROMANA DE TAEKWONDO

Andrei Burca - 505

[ROU] BLACK TIGER

427 - Ognjen Simeunović

[SRB] POBEDNIK

Gabriel Kopi - 457

[SLO] PANTAR

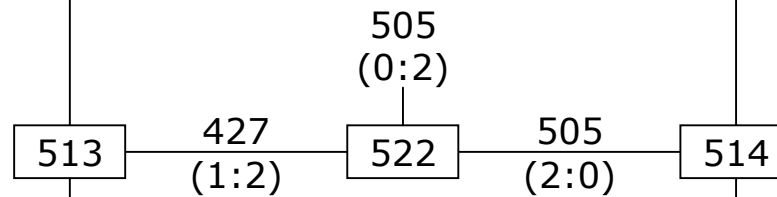

1. Andrei Burca ([ROU] BLACK TIGER)

2. Ognjen Simeunović ([SRB] POBEDNIK)

3. Gabriel Kopi ([SLO] PANTAR)

3. Muntean Dragos ([ROU] ASOCIATIA ROMANA DE ...)

15. Millennium Open
Competition Area 5
Junior A M-73

2 competitors
2024-01-20

121 - Lazar Rašeta
[SRB] GALEB

503
(1:2)
523

Sebastian Busuioc - 503
[ROU] BLACK TIGER

1. Sebastian Busuioc ([ROU] BLACK TIGER)
2. Lazar Rašeta ([SRB] GALEB)
3.
3.

15. Millennium Open 2024
 Par B Pionir 1 MF 8765
 Final
 Group A

Result

As of SUN 21 APR 2024

Rank	Contest No	NOC	Name	Score	Acc/Tech	Total	Detail					
					Pre		Game	Score	Acc/Tech	Pre	Total	Deduct
1	11001	SRB	A. Đorđević - L. Milošević	3.700	1.300	11.1	Game1	3.700	1.300	2.400	11.1	0.0
					2.400		Game2	0.000	0.000	0.000	0.0	0.0

15. Millennium Open 2024
 Par B Pionir 1 MF 4321
 Final
 Group A

Result

As of SUN 21 APR 2024

Rank	Contest No	NOC	Name	Score	Acc/Tech	Total	Detail					
					Pre		Game	Score	Acc/Tech	Pre	Total	Deduct
1	21001	SRB	S. Stojšić - M. Brusin	3.832	1.566	11.5	Game1	3.832	1.566	2.266	11.5	0.0
					2.266		Game2	0.000	0.000	0.000	0.0	0.0

15. Millennium Open 2024
 Tim Pioniri 1 B F 4321
 Final
 Group A

Result

As of SUN 21 APR 2024

Rank	Contest No	NOC	Name	Score	Acc/Tech	Total	Detail					
					Pre		Game	Score	Acc/Tech	Pre	Total	Deduct
1	31001	SRB	S. Stojšić - D. Andrijin - A. Jurošević	3.366	1.300	10.1	Game1	3.366	1.300	2.066	10.1	0.0
					2.066		Game2	0.000	0.000	0.000	0.0	0.0

15. Millennium Open 2024
Pioniri 2 B M 87
Final
Group A

Result

As of SUN 21 APR 2024

Rank	Contest No	NOC	Name	Score	Acc/Tech	Total	Detail					
					Pre		Game	Score	Acc/Tech	Pre	Total	Deduct
1	41002	ROU	CULEA Victor	3.099	1.266	9.3	Game1	3.099	1.266	1.833	9.3	0.0
					1.833		Game2	0.000	0.000	0.000	0.0	0.0
2	41001	ROU	GALEA Nicolas	2.166	0.533	6.5	Game1	2.166	0.533	1.633	6.5	0.0
					1.633		Game2	0.000	0.000	0.000	0.0	0.0
3	41003	ROU	ANDRUNACHE Stefan	2.099	0.466	6.3	Game1	2.099	0.466	1.633	6.3	0.0
					1.633		Game2	0.000	0.000	0.000	0.0	0.0

15. Millennium Open 2024
Pioniri 2 B M 43
Final
Group A

Result

As of SUN 21 APR 2024

Rank	Contest No	NOC	Name	Score	Acc/Tech	Total	Detail					
					Pre		Game	Score	Acc/Tech	Pre	Total	Deduct
1	61001	ROU	BORTOS Rares-Marian	4.166	1.566	12.5	Game1	4.166	1.566	2.600	12.5	0.0
					2.600		Game2	0.000	0.000	0.000	0.0	0.0
2	61002	ROU	ROU AJ Aron	4.000	1.400	12.0	Game1	4.000	1.400	2.600	12.0	0.0
					2.600		Game2	0.000	0.000	0.000	0.0	0.0

15. Millennium Open 2024
Pioniri 2 B M 21
Final
Group A

Result

As of SUN 21 APR 2024

Rank	Contest No	NOC	Name	Score	Acc/Tech	Total	Detail					
					Pre		Game	Score	Acc/Tech	Pre	Total	Deduct
1	71001	SRB	BRUSIN Mihajlo	3.000	1.300	9.0	Game1	3.000	1.300	1.700	9.0	0.0
					1.700		Game2	0.000	0.000	0.000	0.0	0.0

15. Millennium Open 2024
Pioniri 2 B F 87
Final
Group A

Result

As of SUN 21 APR 2024

Rank	Contest No	NOC	Name	Score	Acc/Tech	Total	Detail					
					Pre		Game	Score	Acc/Tech	Pre	Total	Deduct
1	81001	ROU	ANTHEA Iacob	3.366	1.333	10.1	Game1	3.366	1.333	2.033	10.1	0.0
					2.033		Game2	0.000	0.000	0.000	0.0	0.0
2	81002	SRB	BRKIĆ Magdalena	2.933	1.033	8.8	Game1	2.933	1.033	1.900	8.8	0.0
					1.900		Game2	0.000	0.000	0.000	0.0	0.0

15. Millennium Open 2024
Pioniri 2 B F 65
Final
Group A

Result

As of SUN 21 APR 2024

Rank	Contest No	NOC	Name	Score	Acc/Tech	Total	Detail					
					Pre		Game	Score	Acc/Tech	Pre	Total	Deduct
1	91006	SRB	PEROVIĆ Ana	4.100	1.700	12.3	Game1	4.100	1.700	2.400	12.3	0.0
					2.400		Game2	0.000	0.000	0.000	0.0	0.0
3	91004	SRB	MATIJEVIĆ Bojana	3.866	1.566	11.6	Game1	3.866	1.566	2.300	11.6	0.0
					2.300		Game2	0.000	0.000	0.000	0.0	0.0
4	91002	SRB	RADEVIĆ Anja	3.499	1.266	10.5	Game1	3.499	1.266	2.233	10.5	0.0
					2.233		Game2	0.000	0.000	0.000	0.0	0.0
5	91005	SRB	DIKLIĆ Marina	3.132	1.166	9.4	Game1	3.132	1.166	1.966	9.4	0.0
					1.966		Game2	0.000	0.000	0.000	0.0	0.0
6	91003	SRB	JEVTIĆ Anastasija	2.900	1.300	8.7	Game1	2.900	1.300	1.600	8.7	0.0
					1.600		Game2	0.000	0.000	0.000	0.0	0.0

15. Millennium Open 2024
Pioniri 2 B F 21
Final
Group A

Result

As of SUN 21 APR 2024

Rank	Contest No	NOC	Name	Score	Acc/Tech	Total	Detail					
					Pre		Game	Score	Acc/Tech	Pre	Total	Deduct
1	101003	SRB	STOJŠIĆ Sofija	3.299	1.333	9.9	Game1	3.299	1.333	1.966	9.9	0.0
					1.966		Game2	0.000	0.000	0.000	0.0	0.0
2	101001	SRB	JUROŠEVIĆ Anja	2.432	0.766	7.3	Game1	2.432	0.766	1.666	7.3	0.0
					1.666		Game2	0.000	0.000	0.000	0.0	0.0
3	101002	SRB	ANDRIJIN Dunja	2.166	0.566	6.5	Game1	2.166	0.566	1.600	6.5	0.0
					1.600		Game2	0.000	0.000	0.000	0.0	0.0

15. Millennium Open 2024
Kadet B M 87
Final
Group A

Result

As of SUN 21 APR 2024

Rank	Contest No	NOC	Name	Score	Acc/Tech	Total	Detail					
					Pre		Game	Score	Acc/Tech	Pre	Total	Deduct
1	111002	ROU	RAUL Medesan	4.366	1.800	13.1	Game1	4.366	1.800	2.566	13.1	0.0
					2.566		Game2	0.000	0.000	0.000	0.0	0.0
2	111003	ROU	ZOLTAN Silaghi	4.232	1.666	12.7	Game1	4.232	1.666	2.566	12.7	0.0
					2.566		Game2	0.000	0.000	0.000	0.0	0.0
3	111001	ROU	VLADIMIR Iacob	3.599	1.366	10.8	Game1	3.599	1.366	2.233	10.8	0.0
					2.233		Game2	0.000	0.000	0.000	0.0	0.0

15. Millennium Open 2024
Kadet B M 65
Final
Group A

Result

As of SUN 21 APR 2024

Rank	Contest No	NOC	Name	Score	Acc/Tech	Total	Detail					
					Pre		Game	Score	Acc/Tech	Pre	Total	Deduct
1	121002	SRB	SERDAREVIĆ Vanja	4.166	1.633	12.5	Game1	4.166	1.633	2.533	12.5	0.0
					2.533		Game2	0.000	0.000	0.000	0.0	0.0
2	121003	ROU	YANNIS Sipos	3.966	1.566	11.9	Game1	3.966	1.566	2.400	11.9	0.0
					2.400		Game2	0.000	0.000	0.000	0.0	0.0
3	121001	SRB	JEVTIĆ Hristijan	3.600	1.400	10.8	Game1	3.600	1.400	2.200	10.8	0.0
					2.200		Game2	0.000	0.000	0.000	0.0	0.0
4	121004	ROU	POPA Matei	1.966	0.333	5.9	Game1	1.966	0.333	1.633	5.9	0.0
					1.633		Game2	0.000	0.000	0.000	0.0	0.0

15. Millennium Open 2024
Kadet B M 43
Final
Group A

Result

As of SUN 21 APR 2024

Rank	Contest No	NOC	Name	Score	Acc/Tech	Total	Detail					
					Pre		Game	Score	Acc/Tech	Pre	Total	Deduct
1	131005	ROU	ANDREI Boar	4.366	1.766	13.1	Game1	4.366	1.766	2.600	13.1	0.0
					2.600		Game2	0.000	0.000	0.000	0.0	0.0
2	131002	ROU	MISTREANU Stefan	3.633	1.400	10.9	Game1	3.633	1.400	2.233	10.9	0.0
					2.233		Game2	0.000	0.000	0.000	0.0	0.0
3	131003	ROU	MELESCANU Cristian	3.632	1.366	10.9	Game1	3.632	1.366	2.266	10.9	0.0
					2.266		Game2	0.000	0.000	0.000	0.0	0.0
4	131001	ROU	ZAHARIA David	3.599	1.233	10.8	Game1	3.599	1.233	2.366	10.8	0.0
					2.366		Game2	0.000	0.000	0.000	0.0	0.0
5	131004	SRB	VITIĆ Todor	3.032	1.166	9.1	Game1	3.032	1.166	1.866	9.1	0.0
					1.866		Game2	0.000	0.000	0.000	0.0	0.0

15. Millennium Open 2024
Kadet B M 21
Final
Group A

Result

As of SUN 21 APR 2024

Rank	Contest No	NOC	Name	Score	Acc/Tech	Total	Detail					
					Pre		Game	Score	Acc/Tech	Pre	Total	Deduct
1	141001	ROU	MIHAILA Vlad-Felix	4.099	1.666	12.3	Game1	4.099	1.666	2.433	12.3	0.0
					2.433		Game2	0.000	0.000	0.000	0.0	0.0
2	141002	ROU	MIHALCEANU Lucian	3.833	1.533	11.5	Game1	3.833	1.533	2.300	11.5	0.0
					2.300		Game2	0.000	0.000	0.000	0.0	0.0
3	141003	SRB	NENADIĆ Lazar	2.233	0.533	6.7	Game1	2.233	0.533	1.700	6.7	0.0
					1.700		Game2	0.000	0.000	0.000	0.0	0.0

15. Millennium Open 2024
Kadet B F 87
Final
Group A

Result

As of SUN 21 APR 2024

Rank	Contest No	NOC	Name	Score	Acc/Tech	Total	Detail					
					Pre		Game	Score	Acc/Tech	Pre	Total	Deduct
1	151002	ROU	PATRICIA Takacs	4.199	1.666	12.6	Game1	4.199	1.666	2.533	12.6	0.0
					2.533		Game2	0.000	0.000	0.000	0.0	0.0
2	151001	SRB	PETKOVIĆ Đurđa	3.966	1.566	11.9	Game1	3.966	1.566	2.400	11.9	0.0
					2.400		Game2	0.000	0.000	0.000	0.0	0.0

15. Millennium Open 2024
Kadet B F 43
Final
Group A

Result

As of SUN 21 APR 2024

Rank	Contest No	NOC	Name	Score	Acc/Tech	Total	Detail					
					Pre		Game	Score	Acc/Tech	Pre	Total	Deduct
1	161002	ROU	COSTEA Alexandra	4.933	2.100	14.8	Game1	4.933	2.100	2.833	14.8	0.0
					2.833		Game2	0.000	0.000	0.000	0.0	0.0
2	161001	ROU	TEODORA Pavel	4.666	1.933	14.0	Game1	4.666	1.933	2.733	14.0	0.0
					2.733		Game2	0.000	0.000	0.000	0.0	0.0

**15. Millennium Open 2024
Kadet B F 21
Final
Group A**

Result

As of SUN 21 APR 2024

Rank	Contest No	NOC	Name	Score	Acc/Tech	Total	Detail					
					Pre		Game	Score	Acc/Tech	Pre	Total	Deduct
1	171004	ROU	DANADI Petre	4.900	2.100	14.7	Game1	4.900	2.100	2.800	14.7	0.0
					2.800		Game2	0.000	0.000	0.000	0.0	0.0
2	171003	SRB	GAJIĆ Hajdi	4.833	2.000	14.5	Game1	4.833	2.000	2.833	14.5	0.0
					2.833		Game2	0.000	0.000	0.000	0.0	0.0
3	171002	ROU	RAILEANU Alexandra	4.133	1.700	12.4	Game1	4.133	1.700	2.433	12.4	0.0
					2.433		Game2	0.000	0.000	0.000	0.0	0.0
4	171005	SRB	PODKONJAK Milica	4.100	1.700	12.3	Game1	4.100	1.700	2.400	12.3	0.0
					2.400		Game2	0.000	0.000	0.000	0.0	0.0
5	171001	ROU	COSTEA Paula	3.966	1.600	11.9	Game1	3.966	1.600	2.366	11.9	0.0
					2.366		Game2	0.000	0.000	0.000	0.0	0.0

15. Millennium Open 2024
 Junior B M 87
 Final
 Group A

Result

As of SUN 21 APR 2024

Rank	Contest No	NOC	Name	Score	Acc/Tech	Total	Detail					
					Pre		Game	Score	Acc/Tech	Pre	Total	Deduct
1	181001	ROU	DAVID Takacs	4.699	1.933	14.1	Game1	4.699	1.933	2.766	14.1	0.0
					2.766		Game2	0.000	0.000	0.000	0.0	0.0

15. Millennium Open 2024
Junior B M 21
Final
Group A

Result

As of SUN 21 APR 2024

Rank	Contest No	NOC	Name	Score	Acc/Tech	Total	Detail					
					Pre		Game	Score	Acc/Tech	Pre	Total	Deduct
1	191003	ROU	DRAGOS Muntean	4.232	1.766	12.7	Game1	4.232	1.766	2.466	12.7	0.0
					2.466		Game2	0.000	0.000	0.000	0.0	0.0
2	191001	ROU	BURCA Andrei	3.233	1.233	9.7	Game1	3.233	1.233	2.000	9.7	0.0
					2.000		Game2	0.000	0.000	0.000	0.0	0.0
3	191004	SRB	VAŠ Ognjen	3.100	1.100	9.3	Game1	3.100	1.100	2.000	9.3	0.0
					2.000		Game2	0.000	0.000	0.000	0.0	0.0
4	191002	ROU	BUSUIOC Sebastian	2.733	0.900	8.2	Game1	2.733	0.900	1.833	8.2	0.0
					1.833		Game2	0.000	0.000	0.000	0.0	0.0

15. Millennium Open 2024
Junior B F 87
Final
Group A

Result

As of SUN 21 APR 2024

Rank	Contest No	NOC	Name	Score	Acc/Tech	Total	Detail					
					Pre		Game	Score	Acc/Tech	Pre	Total	Deduct
1	201003	SRB	PETKOVIĆ Petra	4.533	1.933	13.6	Game1	4.533	1.933	2.600	13.6	0.0
					2.600		Game2	0.000	0.000	0.000	0.0	0.0
2	201001	ROU	OPREA Claudia	4.366	1.833	13.1	Game1	4.366	1.833	2.533	13.1	0.0
					2.533		Game2	0.000	0.000	0.000	0.0	0.0
3	201005	ROU	DIANA Girlonta	4.366	1.833	13.1	Game1	4.366	1.833	2.533	13.1	0.0
					2.533		Game2	0.000	0.000	0.000	0.0	0.0
4	201004	SRB	UDOVIČIĆ Anastasija	3.600	1.400	10.8	Game1	3.600	1.400	2.200	10.8	0.0
					2.200		Game2	0.000	0.000	0.000	0.0	0.0
5	201002	SRB	JOVANOVIĆ Iva	2.732	0.966	8.2	Game1	2.732	0.966	1.766	8.2	0.0
					1.766		Game2	0.000	0.000	0.000	0.0	0.0

15. Millennium Open 2024
 Junior B F 65
 Final
 Group A

Result

As of SUN 21 APR 2024

Rank	Contest No	NOC	Name	Score	Acc/Tech	Total	Detail					
					Pre		Game	Score	Acc/Tech	Pre	Total	Deduct
1	211002	SRB	STEFANOVIĆ Teodora	4.500	1.900	13.5	Game1	4.500	1.900	2.600	13.5	0.0
					2.600		Game2	0.000	0.000	0.000	0.0	0.0
2	211001	SRB	IVANIŠEVIĆ Andjela	3.400	1.700	10.2	Game1	3.400	1.700	1.700	10.2	0.0
					1.700		Game2	0.000	0.000	0.000	0.0	0.0

15. Millennium Open 2024
Junior B F 43
Final
Group A

Result

As of SUN 21 APR 2024

Rank	Contest No	NOC	Name	Score	Acc/Tech	Total	Detail					
					Pre		Game	Score	Acc/Tech	Pre	Total	Deduct
1	221005	ROU	DIANA Marcu	5.433	2.333	16.3	Game1	5.433	2.333	3.100	16.3	0.0
					3.100		Game2	0.000	0.000	0.000	0.0	0.0
2	221001	ROU	ISVORANU Jessica	5.333	2.233	16.0	Game1	5.333	2.233	3.100	16.0	0.0
					3.100		Game2	0.000	0.000	0.000	0.0	0.0
3	221004	ROU	INGRID Vigh	5.066	2.100	15.2	Game1	5.066	2.100	2.966	15.2	0.0
					2.966		Game2	0.000	0.000	0.000	0.0	0.0
4	221002	ROU	BORDEIANU Denisa	4.200	1.800	12.6	Game1	4.200	1.800	2.400	12.6	0.0
					2.400		Game2	0.000	0.000	0.000	0.0	0.0
5	221003	ROU	CORNEA Cristiana	2.400	0.600	7.2	Game1	2.400	0.600	1.800	7.2	0.0
					1.800		Game2	0.000	0.000	0.000	0.0	0.0

15. Millennium Open 2024
Senior 1 B M 21
Final
Group A

Result

As of SUN 21 APR 2024

Rank	Contest No	NOC	Name	Score	Acc/Tech	Total	Detail					
					Pre		Game	Score	Acc/Tech	Pre	Total	Deduct
1	231002	ROU	DENIS Oltean	4.732	1.966	14.2	Game1	4.732	1.966	2.766	14.2	0.0
					2.766		Game2	0.000	0.000	0.000	0.0	0.0
2	231001	SRB	SOMBORSKI Danilo	3.466	1.266	10.4	Game1	3.466	1.266	2.200	10.4	0.0
					2.200		Game2	0.000	0.000	0.000	0.0	0.0

15. Millennium Open 2024
Senior 1 B F 21
Final
Group A

Result

As of SUN 21 APR 2024

Rank	Contest No	NOC	Name	Score	Acc/Tech	Total	Detail					
					Pre		Game	Score	Acc/Tech	Pre	Total	Deduct
1	241001	ROU	CRISTIANA Muntean	5.233	2.233	15.7	Game1	5.233	2.233	3.000	15.7	0.0
					3.000		Game2	0.000	0.000	0.000	0.0	0.0

15. Millennium Open 2024
Kadet A F
Final
Group A

Result

As of SUN 21 APR 2024

Rank	Contest No	NOC	Name	Score	Acc/Tech	Total	Detail					
					Pre		Game	Score	Acc/Tech	Pre	Total	Deduct
1	251001	SRB	ILIC Petra	4.132	3.232	24.8	Game1	4.066	1.566	2.500	12.2	0.0
					5.033		Game2	4.199	1.666	2.533	12.6	0.0

15. Millennium Open 2024
Junior A F
Final
Group A

Result

As of SUN 21 APR 2024

Rank	Contest No	NOC	Name	Score	Acc/Tech	Total	Detail					
					Pre		Game	Score	Acc/Tech	Pre	Total	Deduct
1	261003	ROU	DARIA Cetean	5.233	4.533	31.4	Game1	5.100	2.200	2.900	15.3	0.0
					5.933		Game2	5.366	2.333	3.033	16.1	0.0
2	261002	ROU	COSTEA Violeta	3.249	2.533	19.5	Game1	2.966	1.100	1.866	8.9	0.0
					3.966		Game2	3.533	1.433	2.100	10.6	0.0
3	261001	ROU	ANGHEL Teodora	2.933	1.833	17.6	Game1	3.000	0.900	2.100	9.0	0.0
					4.033		Game2	2.866	0.933	1.933	8.6	0.0

15. Millennium Open 2024
Senior 1 A M
Final
Group A

Result

As of SUN 21 APR 2024

Rank	Contest No	NOC	Name	Score	Acc/Tech	Total	Detail					
					Pre		Game	Score	Acc/Tech	Pre	Total	Deduct
1	271001	ROU	TUDOR Afrasiabi	4.682	3.599	28.1	Game1	4.899	1.933	2.966	14.7	0.0
					5.766		Game2	4.466	1.666	2.800	13.4	0.0
2	271002	ROU	MIHAI Razvan	4.516	3.633	27.1	Game1	5.133	2.133	3.000	15.4	0.0
					5.400		Game2	3.900	1.500	2.400	11.7	0.0

15. Millennium Open 2024
Senior 2 A M
Final
Group A

Result

As of SUN 21 APR 2024

Rank	Contest No	NOC	Name	Score	Acc/Tech	Total	Detail					
					Pre		Game	Score	Acc/Tech	Pre	Total	Deduct
1	281001	SRB	MIJANOVIĆ Radovan	2.532	1.499	15.2	Game1	1.666	0.166	1.500	5.0	0.0
					3.566		Game2	3.399	1.333	2.066	10.2	0.0

15. Millennium Open 2024
Senior 1 A F
Final
Group A

Result

As of SUN 21 APR 2024

Rank	Contest No	NOC	Name	Score	Acc/Tech	Total	Detail					
					Pre		Game	Score	Acc/Tech	Pre	Total	Deduct
1	291001	SRB	ANTIĆ Maja	5.083	4.233	30.5	Game1	5.233	2.200	3.033	15.7	0.0
					5.933		Game2	4.933	2.033	2.900	14.8	0.0
2	291002	SRB	AĆIN Milana	3.882	2.899	23.3	Game1	4.132	1.666	2.466	12.4	0.0
					4.866		Game2	3.633	1.233	2.400	10.9	0.0

15. Millennium Open 2024
 Par Senior 1 A MF
 Final
 Group A

Result

As of SUN 21 APR 2024

Rank	Contest No	NOC	Name	Score	Acc/Tech	Total	Detail					
					Pre		Game	Score	Acc/Tech	Pre	Total	Deduct
1	301001	ROU	M. Anitic - R. Vladut	4.982	4.199	29.9	Game1	5.066	2.133	2.933	15.2	0.0
					5.766		Game2	4.899	2.066	2.833	14.7	0.0